

2077 MAIN STREET P.O. BOX 528 LYNDEN, WA 98264  
 PH (360)354.5676 FAX (360)318-8687

CUSTOMER \_\_\_\_\_  
 P. O. NUMBER \_\_\_\_\_

PAGE \_\_\_\_\_ OF \_\_\_\_\_  
 DATE \_\_\_\_\_  
 DRAWN BY \_\_\_\_\_

**Note: Any and all changes must be submitted to Lynden Door in writing. No verbal changes will be accepted. Accuracy of information is the responsibility of the customer.**

### HINGE

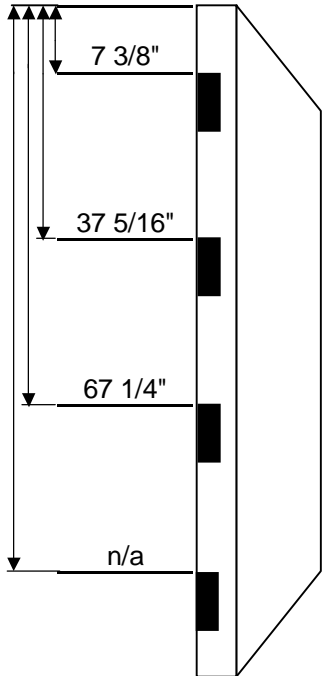

#### HINGES

SIZE 4 1/2"  
 BACKSET 1/4"  
 THICKNESS .134"  
 PIVOT \_\_\_\_\_  
 TEMPLATE NO. \_\_\_\_\_

#### HINGE CORNERS

- 1/4" Radius
- 5/8" Radius
- Square

#### 3 degree BEVELS

- Lock Edge
- Hinge Edge

**NOTE:** WHEN WIRE CHASE IS REQUIRED, DESIGNATE HINGE TO RECEIVE WIRE WITH AN "X"

### ACTIVE

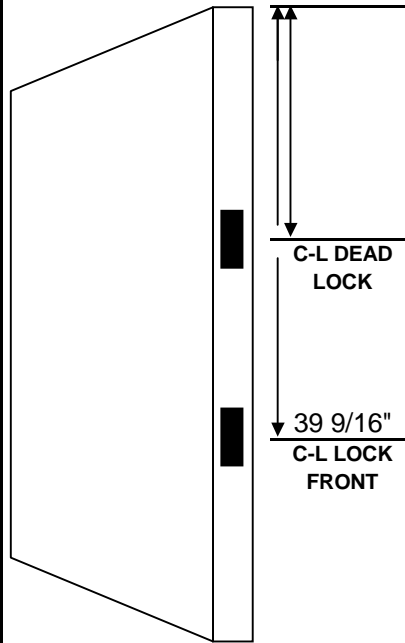

#### LOCKS / EXIT DEVICES

	BORED LOCK	DEAD LOCK
FACE BORE	_____	_____
BOLT BORE	_____	_____
BACKSET	_____	_____
F-P THICKNESS	_____	_____
F-PLATE WIDTH	_____	_____
F-P HEIGHT	_____	_____

#### CORNERS

- 1/4" Radius
- 5/8" Radius
- Square

MORTISE LOCK \_\_\_\_\_  
 CARD LOCK \_\_\_\_\_  
 EXIT DEVICE \_\_\_\_\_

MANUFACTURER \_\_\_\_\_  
 TEMPLATE NO. \_\_\_\_\_  
 FUNCTION NO. \_\_\_\_\_

**NOTE:** \* EXIT DEVICE BACK-SET SHALL BE GIVEN AS THE DISTANCE FROM C-L OF DEVICE TO C-L OF DOOR THICKNESS AT LOCK STILE UNLESS OTHERWISE NOTED.

### INACTIVE

#### STRIKES

- 1-1/4 X 4-7/8" ASA
- 1-1/8 X 2-3/4" LIP
- 1-1/8 X 2-3/4" D-BOLT

DUSTBOX

OTHER \_\_\_\_\_  
 MFG. \_\_\_\_\_  
 TEMP. \_\_\_\_\_

#### FLUSH BOLTS

MFG. \_\_\_\_\_  
 TEMP. NO. \_\_\_\_\_  
 CORNER PRE \_\_\_\_\_

#### 3 degree BEVELS

- Lock Edge
- Hinge Edge

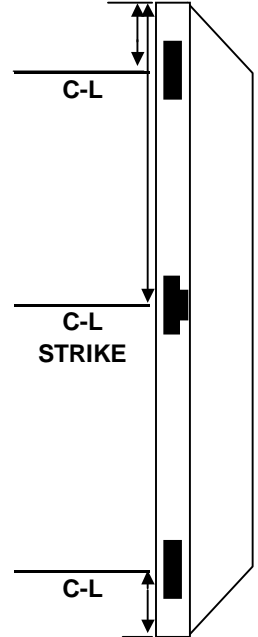

LIABILITY FOR MACHINING ACCURACY WILL BE ASSUMED ONLY UPON RECEIPT OF TEMPLATE, COMPLETED LYNDEN DOOR DETAIL SHEETS AND PHYSICAL SAMPLES AS REQUIRED.

SPEC. NO.

SPEC. NO.

## Amweld 6'8" Locations

2077 MAIN STREET P.O. BOX 528 LYNDEN, WA 98264  
 PH (360)354.5676 FAX (360)318-8687

 CUSTOMER \_\_\_\_\_  
 P. O. NUMBER \_\_\_\_\_

 DATE \_\_\_\_\_  
 DRAWN BY \_\_\_\_\_

**Note: Any and all changes must be submitted to Lynden Door in writing. No verbal changes will be accepted. Accuracy of information is the responsibility of the customer.**

### HINGE

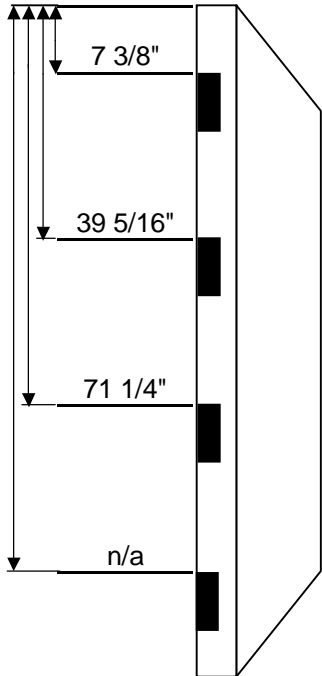

#### HINGES

 SIZE 4 1/2"  
 BACKSET 1/4"  
 THICKNESS .134"  
 PIVOT \_\_\_\_\_  
 TEMPLATE NO. \_\_\_\_\_

#### HINGE CORNERS

- 1/4" Radius  
 5/8" Radius  
 Square

#### 3 degree BEVELS

- Lock Edge  
 Hinge Edge

**NOTE:** WHEN WIRE CHASE IS REQUIRED, DESIGNATE HINGE TO RECEIVE WIRE WITH AN "X"

### ACTIVE

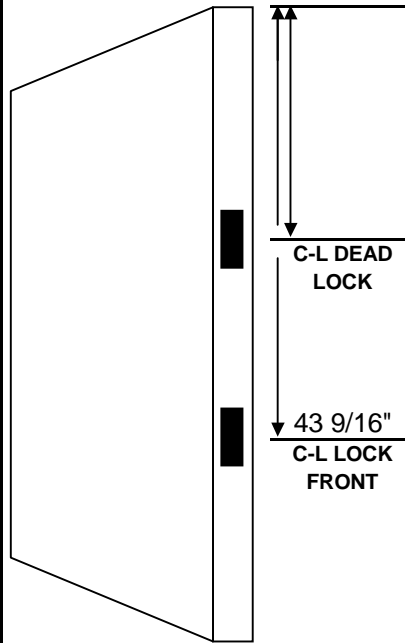

#### LOCKS / EXIT DEVICES

	BORED LOCK	DEAD LOCK
FACE BORE	_____	_____
BOLT BORE	_____	_____
BACKSET	_____	_____
F-P THICKNESS	_____	_____
F-PLATE WIDTH	_____	_____
F-P HEIGHT	_____	_____

#### CORNERS

- 1/4" Radius   
 5/8" Radius   
 Square

MORTISE LOCK \_\_\_\_\_  
 CARD LOCK \_\_\_\_\_  
 EXIT DEVICE \_\_\_\_\_

MANUFACTURER \_\_\_\_\_  
 TEMPLATE NO. \_\_\_\_\_  
 FUNCTION NO. \_\_\_\_\_

**NOTE:** \* EXIT DEVICE BACK-SET SHALL BE GIVEN AS THE DISTANCE FROM C-L OF DEVICE TO C-L OF DOOR THICKNESS AT LOCK STILE UNLESS OTHERWISE NOTED.

### INACTIVE

#### STRIKES

- 1-1/4 X 4-7/8" ASA  
 1-1/8 X 2-3/4" LIP  
 1-1/8 X 2-3/4" D-BOLT

DUSTBOX

OTHER \_\_\_\_\_  
 MFG. \_\_\_\_\_  
 TEMP. \_\_\_\_\_

#### FLUSH BOLTS

MFG. \_\_\_\_\_  
 TEMP. NO. \_\_\_\_\_  
 CORNER PRE \_\_\_\_\_

#### 3 degree BEVELS

- Lock Edge  
 Hinge Edge

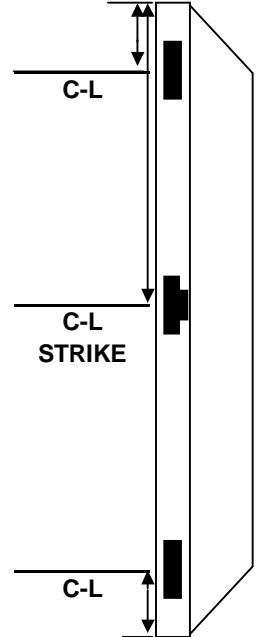

LIABILITY FOR MACHINING ACCURACY WILL BE ASSUMED ONLY UPON RECEIPT OF TEMPLATE, COMPLETED LYNDEN DOOR DETAIL SHEETS AND PHYSICAL SAMPLES AS REQUIRED.

SPEC. NO.

## Amweld 7'0" Locations

SPEC. NO.

2077 MAIN STREET P.O. BOX 528 LYNDEN, WA 98264  
 PH (360)354.5676 FAX (360)318-8687

CUSTOMER \_\_\_\_\_  
 P. O. NUMBER \_\_\_\_\_

PAGE \_\_\_\_\_ OF \_\_\_\_\_  
 DATE \_\_\_\_\_  
 DRAWN BY \_\_\_\_\_

**Note: Any and all changes must be submitted to Lynden Door in writing. No verbal changes will be accepted. Accuracy of information is the responsibility of the customer.**

### HINGE

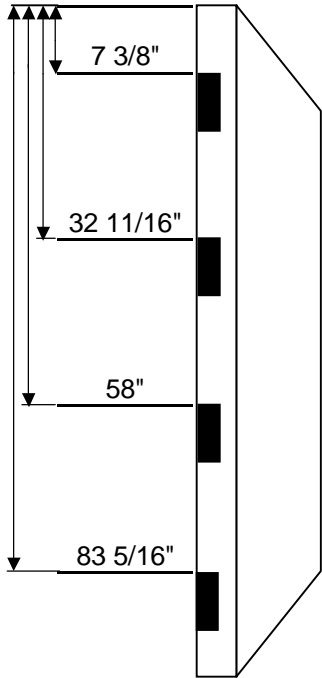

#### HINGES

SIZE 4 1/2"  
 BACKSET 1/4"  
 THICKNESS .134"  
 PIVOT \_\_\_\_\_  
 TEMPLATE NO. \_\_\_\_\_

#### HINGE CORNERS

- 1/4" Radius  
 5/8" Radius  
 Square

#### 3 degree BEVELS

- Lock Edge  
 Hinge Edge

**NOTE:** WHEN WIRE CHASE IS REQUIRED, DESIGNATE HINGE TO RECEIVE WIRE WITH AN "X"

### ACTIVE

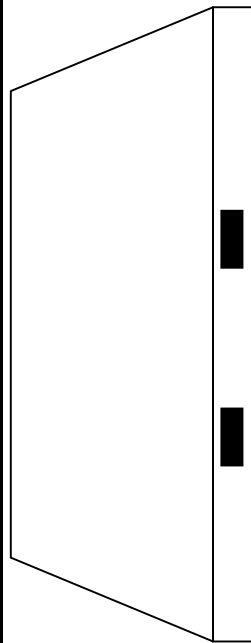

#### LOCKS / EXIT DEVICES

	BORED LOCK	DEAD LOCK
FACE BORE	_____	_____
BOLT BORE	_____	_____
BACKSET	_____	_____
F-P THICKNESS	_____	_____
F-PLATE WIDTH	_____	_____
F-P HEIGHT	_____	_____

#### CORNERS

- 1/4" Radius   
 5/8" Radius   
 Square

MORTISE LOCK \_\_\_\_\_  
 CARD LOCK \_\_\_\_\_  
 EXIT DEVICE \_\_\_\_\_

MANUFACTURER \_\_\_\_\_  
 TEMPLATE NO. \_\_\_\_\_  
 FUNCTION NO. \_\_\_\_\_

**NOTE:** \* EXIT DEVICE BACK-SET SHALL BE GIVEN AS THE DISTANCE FROM C-L OF DEVICE TO C-L OF DOOR THICKNESS AT LOCK STILE UNLESS OTHERWISE NOTED.

### INACTIVE

#### STRIKES

- 1-1/4 X 4-7/8" ASA  
 1-1/8 X 2-3/4" LIP  
 1-1/8 X 2-3/4" D-BOLT

DUSTBOX

OTHER \_\_\_\_\_  
 MFG. \_\_\_\_\_  
 TEMP. \_\_\_\_\_

#### FLUSH BOLTS

MFG. \_\_\_\_\_  
 TEMP. NO. \_\_\_\_\_  
 CORNER PRE \_\_\_\_\_

#### 3 degree BEVELS

- Lock Edge  
 Hinge Edge

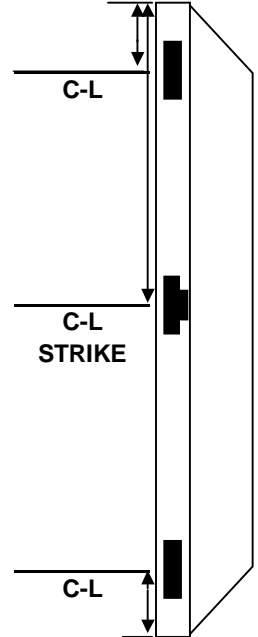

LIABILITY FOR MACHINING ACCURACY WILL BE ASSUMED ONLY UPON RECEIPT OF TEMPLATE, COMPLETED LYNDEN DOOR DETAIL SHEETS AND PHYSICAL SAMPLES AS REQUIRED.

SPEC. NO.

SPEC. NO.

## Amweld 8'0" Locations

2077 MAIN STREET P.O. BOX 528 LYNDEN, WA 98264  
 PH (360)354.5676 FAX (360)318-8687

 CUSTOMER \_\_\_\_\_  
 P. O. NUMBER \_\_\_\_\_

 DATE \_\_\_\_\_  
 DRAWN BY \_\_\_\_\_

**Note: Any and all changes must be submitted to Lynden Door in writing. No verbal changes will be accepted. Accuracy of information is the responsibility of the customer.**

### HINGE

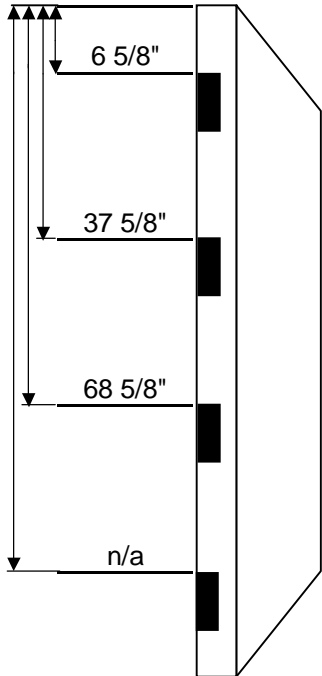

#### HINGES

 SIZE 4 1/2"  
 BACKSET 1/4"  
 THICKNESS .134"  
 PIVOT \_\_\_\_\_  
 TEMPLATE NO. \_\_\_\_\_

#### HINGE CORNERS

- 1/4" Radius  
 5/8" Radius  
 Square

#### 3 degree BEVELS

- Lock Edge  
 Hinge Edge

**NOTE:** WHEN WIRE CHASE IS REQUIRED, DESIGNATE HINGE TO RECEIVE WIRE WITH AN "X"

### ACTIVE

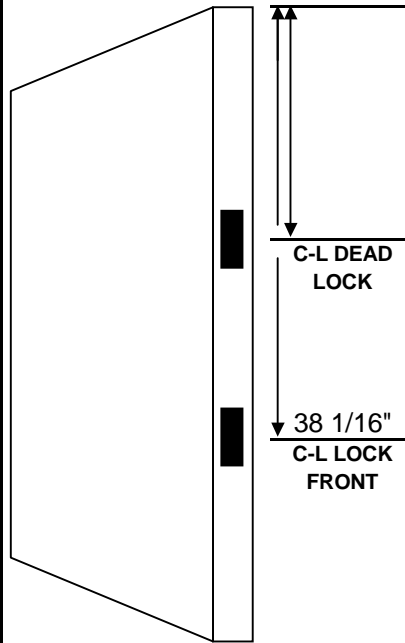

#### LOCKS / EXIT DEVICES

	BORED LOCK	DEAD LOCK
FACE BORE	_____	_____
BOLT BORE	_____	_____
BACKSET	_____	_____
F-P THICKNESS	_____	_____
F-PLATE WIDTH	_____	_____
F-P HEIGHT	_____	_____

#### CORNERS

- 1/4" Radius   
 5/8" Radius   
 Square

MORTISE LOCK \_\_\_\_\_  
 CARD LOCK \_\_\_\_\_  
 EXIT DEVICE \_\_\_\_\_

MANUFACTURER \_\_\_\_\_  
 TEMPLATE NO. \_\_\_\_\_  
 FUNCTION NO. \_\_\_\_\_

**NOTE:** \* EXIT DEVICE BACK-SET SHALL BE GIVEN AS THE DISTANCE FROM C-L OF DEVICE TO C-L OF DOOR THICKNESS AT LOCK STILE UNLESS OTHERWISE NOTED.

### INACTIVE

#### STRIKES

- 1-1/4 X 4-7/8" ASA  
 1-1/8 X 2-3/4" LIP  
 1-1/8 X 2-3/4" D-BOLT

DUSTBOX

OTHER \_\_\_\_\_  
 MFG. \_\_\_\_\_  
 TEMP. \_\_\_\_\_

#### FLUSH BOLTS

MFG. \_\_\_\_\_  
 TEMP. NO. \_\_\_\_\_  
 CORNER PRE \_\_\_\_\_

#### 3 degree BEVELS

- Lock Edge  
 Hinge Edge

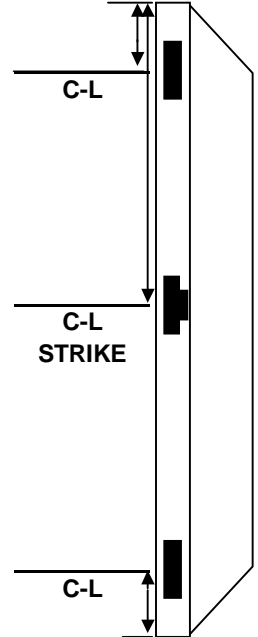

LIABILITY FOR MACHINING ACCURACY WILL BE ASSUMED ONLY UPON RECEIPT OF TEMPLATE, COMPLETED LYNDEN DOOR DETAIL SHEETS AND PHYSICAL SAMPLES AS REQUIRED.

SPEC. NO.

## Ceco 6'8" Locations

SPEC. NO.

2077 MAIN STREET P.O. BOX 528 LYNDEN, WA 98264  
 PH (360)354.5676 FAX (360)318-8687

CUSTOMER \_\_\_\_\_  
 P. O. NUMBER \_\_\_\_\_

PAGE \_\_\_\_\_ OF \_\_\_\_\_  
 DATE \_\_\_\_\_  
 DRAWN BY \_\_\_\_\_

**Note: Any and all changes must be submitted to Lynden Door in writing. No verbal changes will be accepted. Accuracy of information is the responsibility of the customer.**

### HINGE

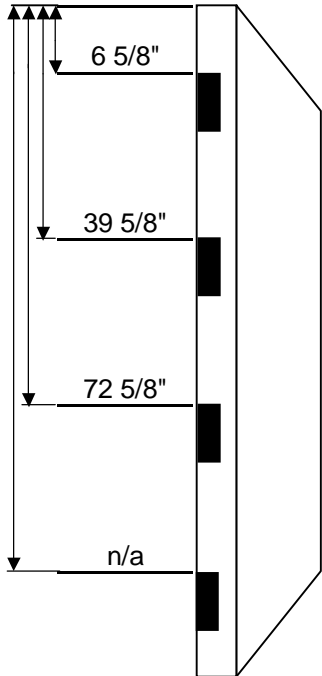

#### HINGES

SIZE 4 1/2"  
 BACKSET 1/4"  
 THICKNESS .134"  
 PIVOT \_\_\_\_\_  
 TEMPLATE NO. \_\_\_\_\_

#### HINGE CORNERS

- 1/4" Radius
- 5/8" Radius
- Square

#### 3 degree BEVELS

- Lock Edge
- Hinge Edge

**NOTE:** WHEN WIRE CHASE IS REQUIRED, DESIGNATE HINGE TO RECEIVE WIRE WITH AN "X"

### ACTIVE

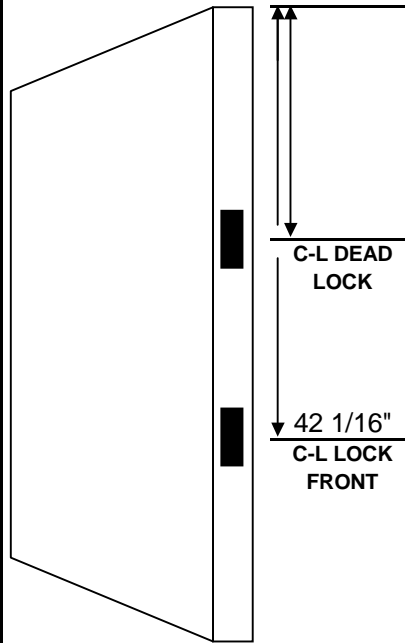

#### LOCKS / EXIT DEVICES

	BORED LOCK	DEAD LOCK
FACE BORE	_____	_____
BOLT BORE	_____	_____
BACKSET	_____	_____
F-P THICKNESS	_____	_____
F-PLATE WIDTH	_____	_____
F-P HEIGHT	_____	_____

#### CORNERS

- 1/4" Radius
- 5/8" Radius
- Square

MORTISE LOCK \_\_\_\_\_  
 CARD LOCK \_\_\_\_\_  
 EXIT DEVICE \_\_\_\_\_

MANUFACTURER \_\_\_\_\_  
 TEMPLATE NO. \_\_\_\_\_  
 FUNCTION NO. \_\_\_\_\_

**NOTE:** \* EXIT DEVICE BACK-SET SHALL BE GIVEN AS THE DISTANCE FROM C-L OF DEVICE TO C-L OF DOOR THICKNESS AT LOCK STILE UNLESS OTHERWISE NOTED.

### INACTIVE

#### STRIKES

- 1-1/4 X 4-7/8" ASA
- 1-1/8 X 2-3/4" LIP
- 1-1/8 X 2-3/4" D-BOLT

DUSTBOX

OTHER \_\_\_\_\_  
 MFG. \_\_\_\_\_  
 TEMP. \_\_\_\_\_

#### FLUSH BOLTS

MFG. \_\_\_\_\_  
 TEMP. NO. \_\_\_\_\_  
 CORNER PRE \_\_\_\_\_

#### 3 degree BEVELS

- Lock Edge
- Hinge Edge

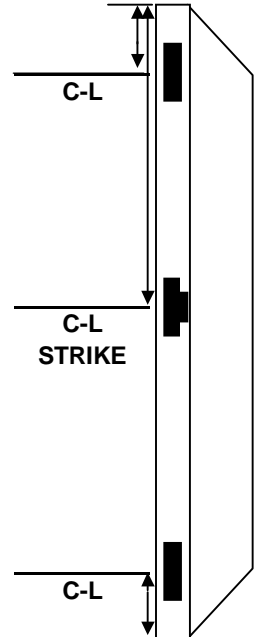

LIABILITY FOR MACHINING ACCURACY WILL BE ASSUMED ONLY UPON RECEIPT OF TEMPLATE, COMPLETED LYNDEN DOOR DETAIL SHEETS AND PHYSICAL SAMPLES AS REQUIRED.

SPEC. NO.

SPEC. NO.

## Ceco 7'0" Locations

2077 MAIN STREET P.O. BOX 528 LYNDEN, WA 98264  
 PH (360)354.5676 FAX (360)318-8687

 CUSTOMER \_\_\_\_\_  
 P. O. NUMBER \_\_\_\_\_

 DATE \_\_\_\_\_  
 DRAWN BY \_\_\_\_\_

Note: Any and all changes must be submitted to Lynden Door in writing. No verbal changes will be accepted. Accuracy of information is the responsibility of the customer.

### HINGE

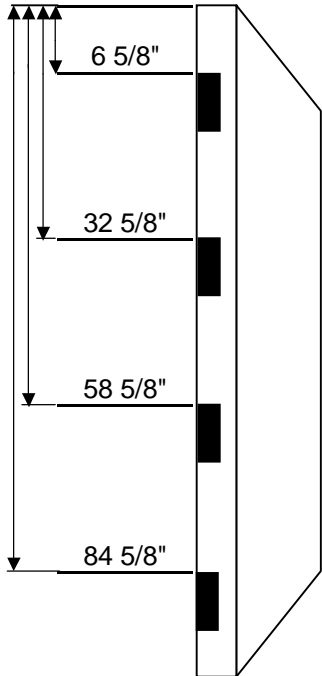

#### HINGES

 SIZE 4 1/2"  
 BACKSET 1/4"  
 THICKNESS .134"  
 PIVOT \_\_\_\_\_  
 TEMPLATE NO. \_\_\_\_\_

#### HINGE CORNERS

- 1/4" Radius  
 5/8" Radius  
 Square

#### 3 degree BEVELS

- Lock Edge  
 Hinge Edge

NOTE: WHEN WIRE CHASE IS REQUIRED, DESIGNATE HINGE TO RECEIVE WIRE WITH AN "X"

### ACTIVE

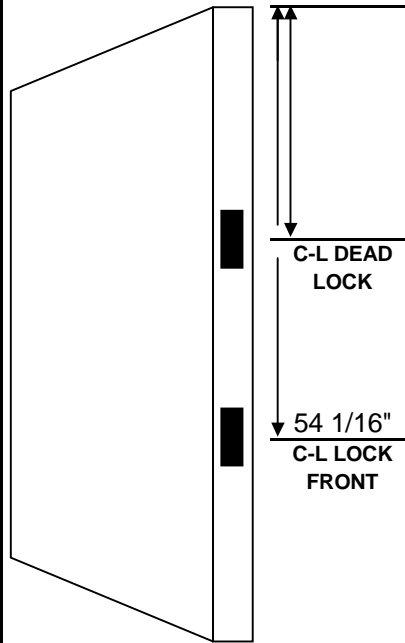

#### LOCKS / EXIT DEVICES

	BORED LOCK	DEAD LOCK
FACE BORE	_____	_____
BOLT BORE	_____	_____
BACKSET	_____	_____
F-P THICKNESS	_____	_____
F-PLATE WIDTH	_____	_____
F-P HEIGHT	_____	_____

#### CORNERS

- 1/4" Radius   
 5/8" Radius   
 Square

MORTISE LOCK \_\_\_\_\_  
 CARD LOCK \_\_\_\_\_  
 EXIT DEVICE \_\_\_\_\_

MANUFACTURER \_\_\_\_\_  
 TEMPLATE NO. \_\_\_\_\_  
 FUNCTION NO. \_\_\_\_\_

NOTE: \* EXIT DEVICE BACK-SET SHALL BE GIVEN AS THE DISTANCE FROM C-L OF DEVICE TO C-L OF DOOR THICKNESS AT LOCK STILE UNLESS OTHERWISE NOTED.

### INACTIVE

#### STRIKES

- 1-1/4 X 4-7/8" ASA  
 1-1/8 X 2-3/4" LIP  
 1-1/8 X 2-3/4" D-BOLT

DUSTBOX

OTHER \_\_\_\_\_  
 MFG. \_\_\_\_\_  
 TEMP. \_\_\_\_\_

#### FLUSH BOLTS

MFG. \_\_\_\_\_  
 TEMP. NO. \_\_\_\_\_  
 CORNER PRE \_\_\_\_\_

#### 3 degree BEVELS

- Lock Edge  
 Hinge Edge

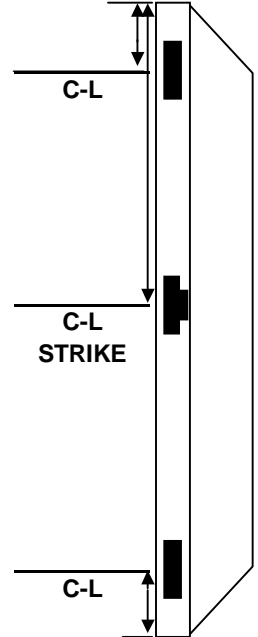

LIABILITY FOR MACHINING ACCURACY WILL BE ASSUMED ONLY UPON RECEIPT OF TEMPLATE, COMPLETED LYNDEN DOOR DETAIL SHEETS AND PHYSICAL SAMPLES AS REQUIRED.

SPEC. NO.

## Ceco 8'0" Locations

SPEC. NO.

2077 MAIN STREET P.O. BOX 528 LYNDEN, WA 98264  
 PH (360)354.5676 FAX (360)318-8687

CUSTOMER \_\_\_\_\_  
 P. O. NUMBER \_\_\_\_\_

PAGE \_\_\_\_\_ OF \_\_\_\_\_  
 DATE \_\_\_\_\_  
 DRAWN BY \_\_\_\_\_

**Note: Any and all changes must be submitted to Lynden Door in writing. No verbal changes will be accepted. Accuracy of information is the responsibility of the customer.**

### HINGE

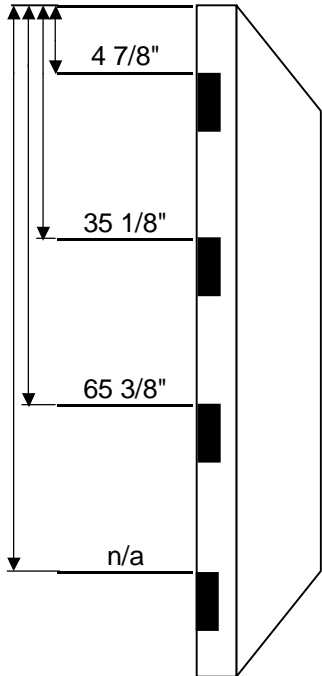

#### HINGES

SIZE 4 1/2"  
 BACKSET 1/4"  
 THICKNESS .134"  
 PIVOT \_\_\_\_\_  
 TEMPLATE NO. \_\_\_\_\_

#### HINGE CORNERS

- 1/4" Radius  
 5/8" Radius  
 Square

#### 3 degree BEVELS

- Lock Edge  
 Hinge Edge

**NOTE:** WHEN WIRE CHASE IS REQUIRED, DESIGNATE HINGE TO RECEIVE WIRE WITH AN "X"

### ACTIVE

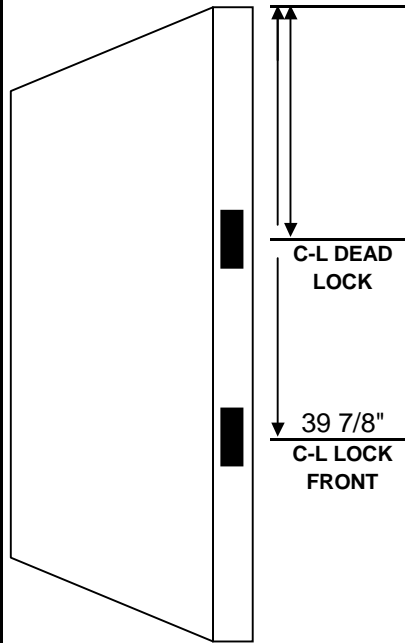

#### LOCKS / EXIT DEVICES

	BORED LOCK	DEAD LOCK
FACE BORE	_____	_____
BOLT BORE	_____	_____
BACKSET	_____	_____
F-P THICKNESS	_____	_____
F-PLATE WIDTH	_____	_____
F-P HEIGHT	_____	_____

#### CORNERS

- 1/4" Radius   
 5/8" Radius   
 Square

MORTISE LOCK \_\_\_\_\_  
 CARD LOCK \_\_\_\_\_  
 EXIT DEVICE \_\_\_\_\_

MANUFACTURER \_\_\_\_\_  
 TEMPLATE NO. \_\_\_\_\_  
 FUNCTION NO. \_\_\_\_\_

**NOTE:** \* EXIT DEVICE BACK-SET SHALL BE GIVEN AS THE DISTANCE FROM C-L OF DEVICE TO C-L OF DOOR THICKNESS AT LOCK STILE UNLESS OTHERWISE NOTED.

### INACTIVE

#### STRIKES

- 1-1/4 X 4-7/8" ASA  
 1-1/8 X 2-3/4" LIP  
 1-1/8 X 2-3/4" D-BOLT

DUSTBOX

OTHER \_\_\_\_\_  
 MFG. \_\_\_\_\_  
 TEMP. \_\_\_\_\_

#### FLUSH BOLTS

MFG. \_\_\_\_\_  
 TEMP. NO. \_\_\_\_\_  
 CORNER PRE \_\_\_\_\_

#### 3 degree BEVELS

- Lock Edge  
 Hinge Edge

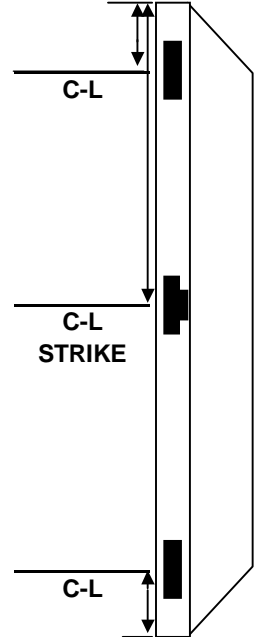

LIABILITY FOR MACHINING ACCURACY WILL BE ASSUMED ONLY UPON RECEIPT OF TEMPLATE, COMPLETED LYNDEN DOOR DETAIL SHEETS AND PHYSICAL SAMPLES AS REQUIRED.

SPEC. NO.

## Curries 6'8" Locations

SPEC. NO.

2077 MAIN STREET P.O. BOX 528 LYNDEN, WA 98264  
 PH (360)354.5676 FAX (360)318-8687

CUSTOMER \_\_\_\_\_  
 P. O. NUMBER \_\_\_\_\_

PAGE \_\_\_\_\_ OF \_\_\_\_\_  
 DATE \_\_\_\_\_  
 DRAWN BY \_\_\_\_\_

**Note: Any and all changes must be submitted to Lynden Door in writing. No verbal changes will be accepted. Accuracy of information is the responsibility of the customer.**

### HINGE

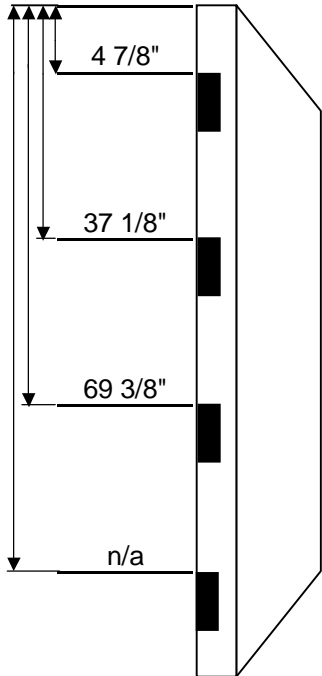

#### HINGES

SIZE 4 1/2"  
 BACKSET 1/4"  
 THICKNESS .134"  
 PIVOT \_\_\_\_\_  
 TEMPLATE NO. \_\_\_\_\_

#### HINGE CORNERS

- 1/4" Radius
- 5/8" Radius
- Square

#### 3 degree BEVELS

- Lock Edge
- Hinge Edge

**NOTE:** WHEN WIRE CHASE IS REQUIRED, DESIGNATE HINGE TO RECEIVE WIRE WITH AN "X"

### ACTIVE

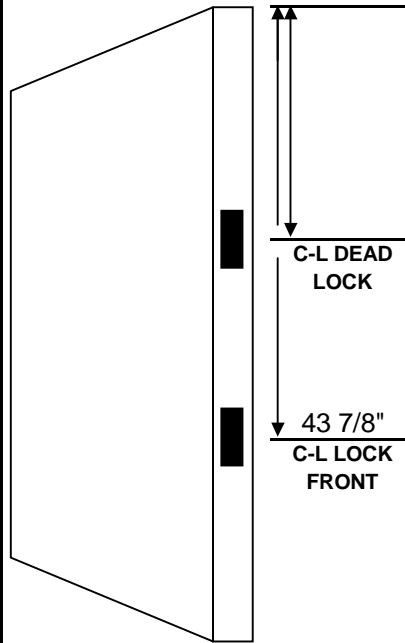

#### LOCKS / EXIT DEVICES

	BORED LOCK	DEAD LOCK
FACE BORE	_____	_____
BOLT BORE	_____	_____
BACKSET	_____	_____
F-P THICKNESS	_____	_____
F-PLATE WIDTH	_____	_____
F-P HEIGHT	_____	_____

#### CORNERS

- 1/4" Radius
- 5/8" Radius
- Square

MORTISE LOCK \_\_\_\_\_  
 CARD LOCK \_\_\_\_\_  
 EXIT DEVICE \_\_\_\_\_

MANUFACTURER \_\_\_\_\_  
 TEMPLATE NO. \_\_\_\_\_  
 FUNCTION NO. \_\_\_\_\_

**NOTE:** \* EXIT DEVICE BACK-SET SHALL BE GIVEN AS THE DISTANCE FROM C-L OF DEVICE TO C-L OF DOOR THICKNESS AT LOCK STILE UNLESS OTHERWISE NOTED.

### INACTIVE

#### STRIKES

- 1-1/4 X 4-7/8" ASA
- 1-1/8 X 2-3/4" LIP
- 1-1/8 X 2-3/4" D-BOLT

DUSTBOX

OTHER \_\_\_\_\_  
 MFG. \_\_\_\_\_  
 TEMP. \_\_\_\_\_

#### FLUSH BOLTS

MFG. \_\_\_\_\_  
 TEMP. NO. \_\_\_\_\_  
 CORNER PRE \_\_\_\_\_

#### 3 degree BEVELS

- Lock Edge
- Hinge Edge

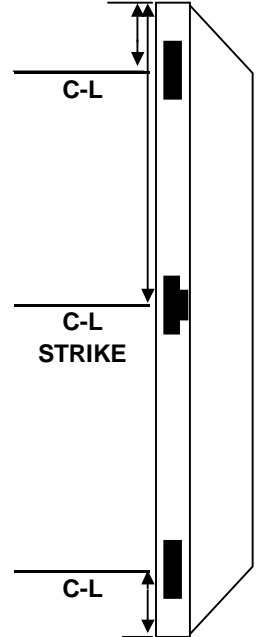

LIABILITY FOR MACHINING ACCURACY WILL BE ASSUMED ONLY UPON RECEIPT OF TEMPLATE, COMPLETED LYNDEN DOOR DETAIL SHEETS AND PHYSICAL SAMPLES AS REQUIRED.

SPEC. NO.

## Curries 7'0" Locations

SPEC. NO.



2077 MAIN STREET P.O. BOX 528 LYNDEN, WA 98264  
 PH (360)354.5676 FAX (360)318-8687

 CUSTOMER \_\_\_\_\_  
 P. O. NUMBER \_\_\_\_\_

 DATE \_\_\_\_\_  
 DRAWN BY \_\_\_\_\_

Note: Any and all changes must be submitted to Lynden Door in writing. No verbal changes will be accepted. Accuracy of information is the responsibility of the customer.

### HINGE

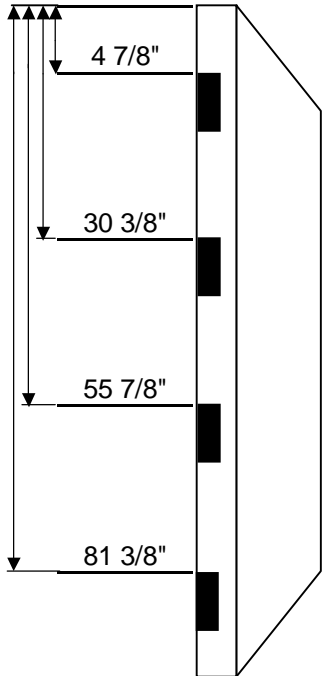

#### HINGES

 SIZE 4 1/2"  
 BACKSET 1/4"  
 THICKNESS .134"  
 PIVOT \_\_\_\_\_  
 TEMPLATE NO. \_\_\_\_\_

#### HINGE CORNERS

- 1/4" Radius  
 5/8" Radius  
 Square

#### 3 degree BEVELS

- Lock Edge  
 Hinge Edge

NOTE: WHEN WIRE CHASE IS REQUIRED, DESIGNATE HINGE TO RECEIVE WIRE WITH AN "X"

### ACTIVE

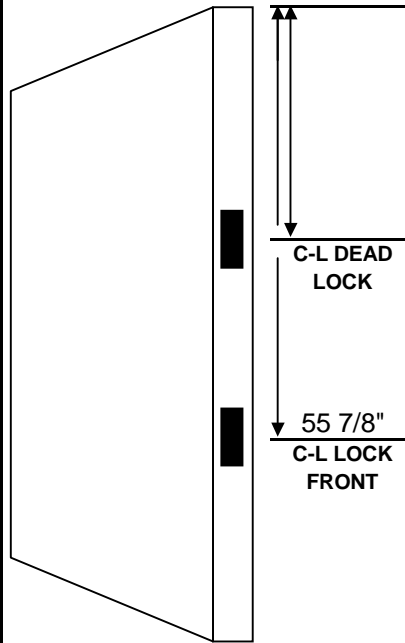

#### LOCKS / EXIT DEVICES

	BORED LOCK	DEAD LOCK
FACE BORE	_____	_____
BOLT BORE	_____	_____
BACKSET	_____	_____
F-P THICKNESS	_____	_____
F-PLATE WIDTH	_____	_____
F-P HEIGHT	_____	_____

#### CORNERS

- 1/4" Radius   
 5/8" Radius   
 Square

MORTISE LOCK \_\_\_\_\_  
 CARD LOCK \_\_\_\_\_  
 EXIT DEVICE \_\_\_\_\_

MANUFACTURER \_\_\_\_\_  
 TEMPLATE NO. \_\_\_\_\_  
 FUNCTION NO. \_\_\_\_\_

NOTE: \* EXIT DEVICE BACK-SET SHALL BE GIVEN AS THE DISTANCE FROM C-L OF DEVICE TO C-L OF DOOR THICKNESS AT LOCK STILE UNLESS OTHERWISE NOTED.

### INACTIVE

#### STRIKES

- 1-1/4 X 4-7/8" ASA  
 1-1/8 X 2-3/4" LIP  
 1-1/8 X 2-3/4" D-BOLT

DUSTBOX

OTHER \_\_\_\_\_  
 MFG. \_\_\_\_\_  
 TEMP. \_\_\_\_\_

#### FLUSH BOLTS

MFG. \_\_\_\_\_  
 TEMP. NO. \_\_\_\_\_  
 CORNER PRE \_\_\_\_\_

#### 3 degree BEVELS

- Lock Edge  
 Hinge Edge

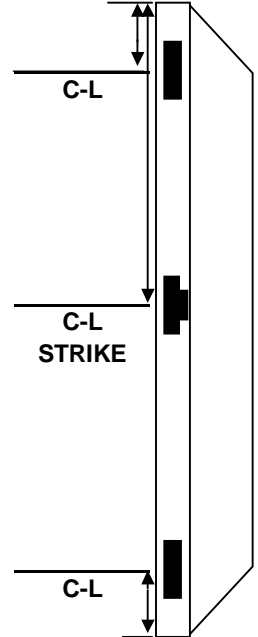

LIABILITY FOR MACHINING ACCURACY WILL BE ASSUMED ONLY UPON RECEIPT OF TEMPLATE, COMPLETED LYNDEN DOOR DETAIL SHEETS AND PHYSICAL SAMPLES AS REQUIRED.

SPEC. NO.

## Curries 8'0" Locations

SPEC. NO.

2077 MAIN STREET P.O. BOX 528 LYNDEN, WA 98264  
 PH (360)354.5676 FAX (360)318-8687

CUSTOMER \_\_\_\_\_  
 P. O. NUMBER \_\_\_\_\_

PAGE \_\_\_\_\_ OF \_\_\_\_\_  
 DATE \_\_\_\_\_  
 DRAWN BY \_\_\_\_\_

**Note: Any and all changes must be submitted to Lynden Door in writing. No verbal changes will be accepted. Accuracy of information is the responsibility of the customer.**

### HINGE

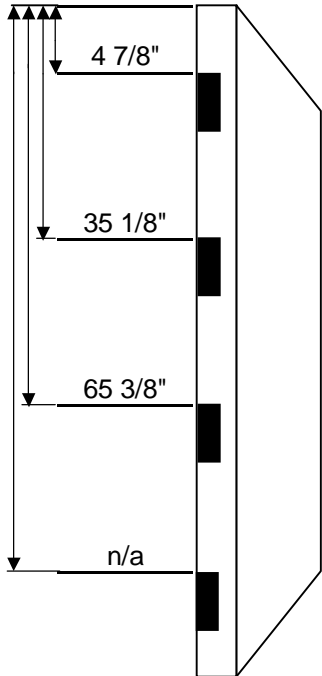

#### HINGES

SIZE 4 1/2"  
 BACKSET 1/4"  
 THICKNESS .134"  
 PIVOT \_\_\_\_\_  
 TEMPLATE NO. \_\_\_\_\_

#### HINGE CORNERS

- 1/4" Radius  
 5/8" Radius  
 Square

#### 3 degree BEVELS

- Lock Edge  
 Hinge Edge

**NOTE:** WHEN WIRE CHASE IS REQUIRED, DESIGNATE HINGE TO RECEIVE WIRE WITH AN "X"

### ACTIVE

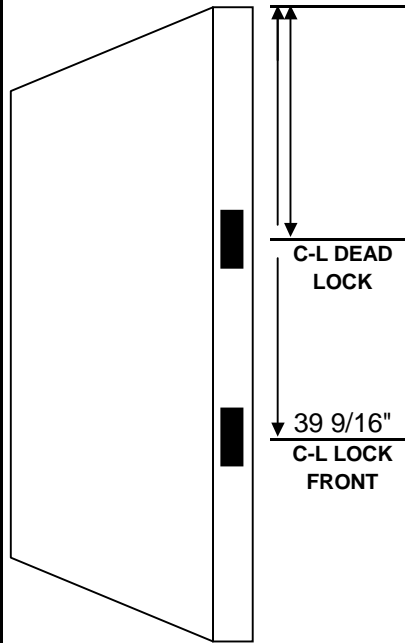

#### LOCKS / EXIT DEVICES

	BORED LOCK	DEAD LOCK
FACE BORE	_____	_____
BOLT BORE	_____	_____
BACKSET	_____	_____
F-P THICKNESS	_____	_____
F-PLATE WIDTH	_____	_____
F-P HEIGHT	_____	_____

#### CORNERS

- 1/4" Radius   
 5/8" Radius   
 Square

MORTISE LOCK \_\_\_\_\_  
 CARD LOCK \_\_\_\_\_  
 EXIT DEVICE \_\_\_\_\_

MANUFACTURER \_\_\_\_\_  
 TEMPLATE NO. \_\_\_\_\_  
 FUNCTION NO. \_\_\_\_\_

**NOTE:** \* EXIT DEVICE BACK-SET SHALL BE GIVEN AS THE DISTANCE FROM C-L OF DEVICE TO C-L OF DOOR THICKNESS AT LOCK STILE UNLESS OTHERWISE NOTED.

### INACTIVE

#### STRIKES

- 1-1/4 X 4-7/8" ASA  
 1-1/8 X 2-3/4" LIP  
 1-1/8 X 2-3/4" D-BOLT

DUSTBOX

OTHER \_\_\_\_\_  
 MFG. \_\_\_\_\_  
 TEMP. \_\_\_\_\_

#### FLUSH BOLTS

MFG. \_\_\_\_\_  
 TEMP. NO. \_\_\_\_\_  
 CORNER PRE \_\_\_\_\_

#### 3 degree BEVELS

- Lock Edge  
 Hinge Edge

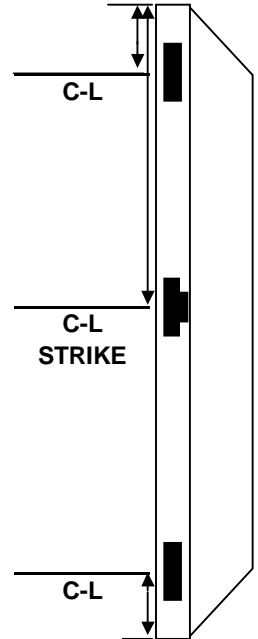

LIABILITY FOR MACHINING ACCURACY WILL BE ASSUMED ONLY UPON RECEIPT OF TEMPLATE, COMPLETED LYNDEN DOOR DETAIL SHEETS AND PHYSICAL SAMPLES AS REQUIRED.

SPEC. NO.

## Deansteel 6'8" Locations

SPEC. NO.

2077 MAIN STREET P.O. BOX 528 LYNDEN, WA 98264  
 PH (360)354.5676 FAX (360)318-8687

 CUSTOMER \_\_\_\_\_  
 P. O. NUMBER \_\_\_\_\_

 DATE \_\_\_\_\_  
 DRAWN BY \_\_\_\_\_

**Note: Any and all changes must be submitted to Lynden Door in writing. No verbal changes will be accepted. Accuracy of information is the responsibility of the customer.**

### HINGE

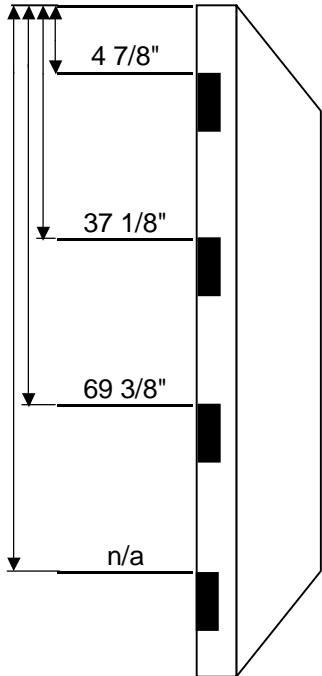

#### HINGES

 SIZE 4 1/2"  
 BACKSET 1/4"  
 THICKNESS .134"  
 PIVOT \_\_\_\_\_  
 TEMPLATE NO. \_\_\_\_\_

#### HINGE CORNERS

- 1/4" Radius  
 5/8" Radius  
 Square

#### 3 degree BEVELS

- Lock Edge  
 Hinge Edge

**NOTE:** WHEN WIRE CHASE IS REQUIRED, DESIGNATE HINGE TO RECEIVE WIRE WITH AN "X"

### ACTIVE

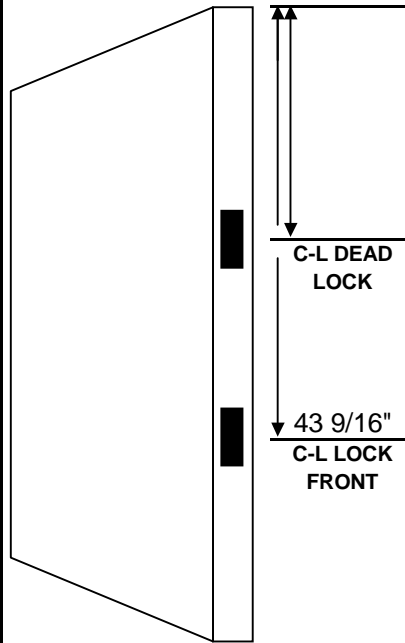

#### LOCKS / EXIT DEVICES

	BORED LOCK	DEAD LOCK
FACE BORE	_____	_____
BOLT BORE	_____	_____
BACKSET	_____	_____
F-P THICKNESS	_____	_____
F-PLATE WIDTH	_____	_____
F-P HEIGHT	_____	_____

#### CORNERS

- 1/4" Radius   
 5/8" Radius   
 Square

MORTISE LOCK \_\_\_\_\_  
 CARD LOCK \_\_\_\_\_  
 EXIT DEVICE \_\_\_\_\_

MANUFACTURER \_\_\_\_\_  
 TEMPLATE NO. \_\_\_\_\_  
 FUNCTION NO. \_\_\_\_\_

**NOTE:** \* EXIT DEVICE BACK-SET SHALL BE GIVEN AS THE DISTANCE FROM C-L OF DEVICE TO C-L OF DOOR THICKNESS AT LOCK STILE UNLESS OTHERWISE NOTED.

### INACTIVE

#### STRIKES

- 1-1/4 X 4-7/8" ASA  
 1-1/8 X 2-3/4" LIP  
 1-1/8 X 2-3/4" D-BOLT

DUSTBOX

OTHER \_\_\_\_\_  
 MFG. \_\_\_\_\_  
 TEMP. \_\_\_\_\_

#### FLUSH BOLTS

MFG. \_\_\_\_\_  
 TEMP. NO. \_\_\_\_\_  
 CORNER PRE \_\_\_\_\_

#### 3 degree BEVELS

- Lock Edge  
 Hinge Edge

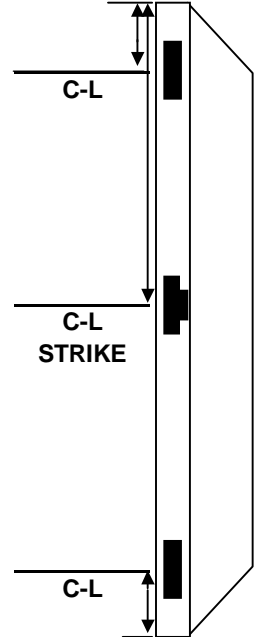

LIABILITY FOR MACHINING ACCURACY WILL BE ASSUMED ONLY UPON RECEIPT OF TEMPLATE, COMPLETED LYNDEN DOOR DETAIL SHEETS AND PHYSICAL SAMPLES AS REQUIRED.

SPEC. NO.

## Deansteel 7'0" Locations

SPEC. NO.

2077 MAIN STREET P.O. BOX 528 LYNDEN, WA 98264  
 PH (360)354.5676 FAX (360)318-8687

 CUSTOMER \_\_\_\_\_  
 P. O. NUMBER \_\_\_\_\_

 DATE \_\_\_\_\_  
 DRAWN BY \_\_\_\_\_

**Note: Any and all changes must be submitted to Lynden Door in writing. No verbal changes will be accepted. Accuracy of information is the responsibility of the customer.**

### HINGE

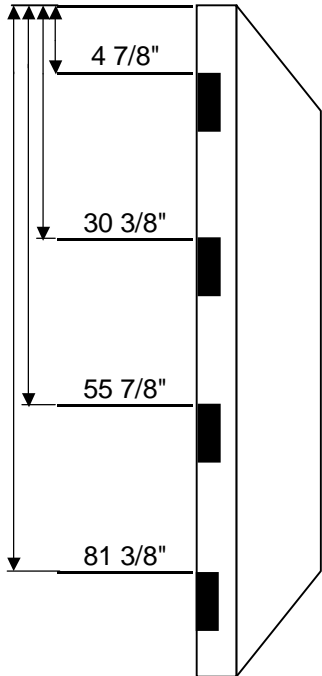

#### HINGES

 SIZE 4 1/2"  
 BACKSET 1/4"  
 THICKNESS .134"  
 PIVOT \_\_\_\_\_  
 TEMPLATE NO. \_\_\_\_\_

#### HINGE CORNERS

- 1/4" Radius  
 5/8" Radius  
 Square

#### 3 degree BEVELS

- Lock Edge  
 Hinge Edge

**NOTE:** WHEN WIRE CHASE IS REQUIRED, DESIGNATE HINGE TO RECEIVE WIRE WITH AN "X"

### ACTIVE

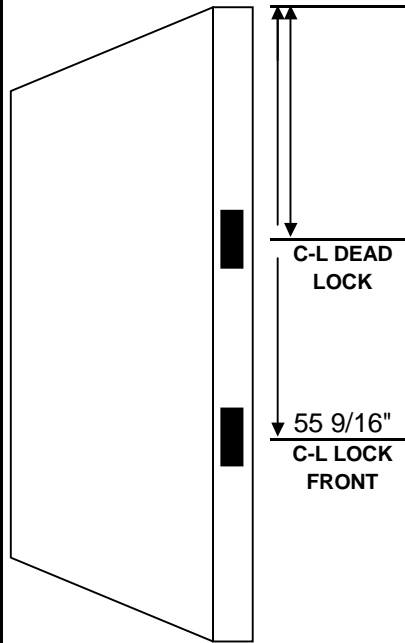

#### LOCKS / EXIT DEVICES

	BORED LOCK	DEAD LOCK
FACE BORE	_____	_____
BOLT BORE	_____	_____
BACKSET	_____	_____
F-P THICKNESS	_____	_____
F-PLATE WIDTH	_____	_____
F-P HEIGHT	_____	_____

#### CORNERS

- 1/4" Radius   
 5/8" Radius   
 Square

MORTISE LOCK \_\_\_\_\_  
 CARD LOCK \_\_\_\_\_  
 EXIT DEVICE \_\_\_\_\_

MANUFACTURER \_\_\_\_\_  
 TEMPLATE NO. \_\_\_\_\_  
 FUNCTION NO. \_\_\_\_\_

**NOTE:** \* EXIT DEVICE BACK-SET SHALL BE GIVEN AS THE DISTANCE FROM C-L OF DEVICE TO C-L OF DOOR THICKNESS AT LOCK STILE UNLESS OTHERWISE NOTED.

### INACTIVE

#### STRIKES

- 1-1/4 X 4-7/8" ASA  
 1-1/8 X 2-3/4" LIP  
 1-1/8 X 2-3/4" D-BOLT

DUSTBOX

OTHER \_\_\_\_\_  
 MFG. \_\_\_\_\_  
 TEMP. \_\_\_\_\_

#### FLUSH BOLTS

MFG. \_\_\_\_\_  
 TEMP. NO. \_\_\_\_\_  
 CORNER PRE \_\_\_\_\_

#### 3 degree BEVELS

- Lock Edge  
 Hinge Edge

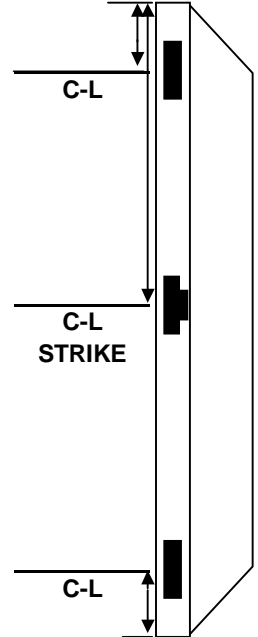

LIABILITY FOR MACHINING ACCURACY WILL BE ASSUMED ONLY UPON RECEIPT OF TEMPLATE, COMPLETED LYNDEN DOOR DETAIL SHEETS AND PHYSICAL SAMPLES AS REQUIRED.

SPEC. NO.

## Deansteel 8'0" Locations

SPEC. NO.

2077 MAIN STREET P.O. BOX 528 LYNDEN, WA 98264  
 PH (360)354.5676 FAX (360)318-8687

 CUSTOMER \_\_\_\_\_  
 P. O. NUMBER \_\_\_\_\_

 DATE \_\_\_\_\_  
 DRAWN BY \_\_\_\_\_

Note: Any and all changes must be submitted to Lynden Door in writing. No verbal changes will be accepted. Accuracy of information is the responsibility of the customer.

### HINGE

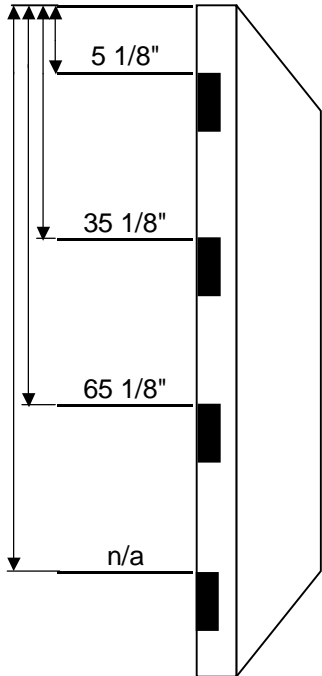

#### HINGES

 SIZE 4 1/2"  
 BACKSET 1/4"  
 THICKNESS .134"  
 PIVOT \_\_\_\_\_  
 TEMPLATE NO. \_\_\_\_\_

#### HINGE CORNERS

- 1/4" Radius  
 5/8" Radius  
 Square

#### 3 degree BEVELS

- Lock Edge  
 Hinge Edge

NOTE: WHEN WIRE CHASE IS REQUIRED, DESIGNATE HINGE TO RECEIVE WIRE WITH AN "X"

### ACTIVE

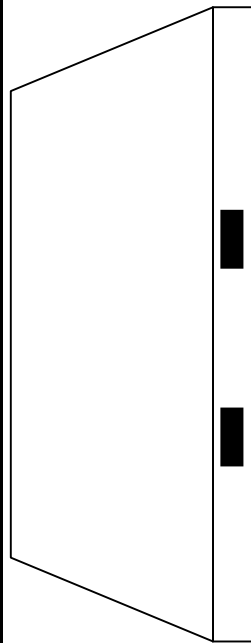

#### LOCKS / EXIT DEVICES

	BORED LOCK	DEAD LOCK
FACE BORE	_____	_____
BOLT BORE	_____	_____
BACKSET	_____	_____
F-P THICKNESS	_____	_____
F-PLATE WIDTH	_____	_____
F-P HEIGHT	_____	_____

#### CORNERS

- 1/4" Radius   
 5/8" Radius   
 Square

MORTISE LOCK \_\_\_\_\_  
 CARD LOCK \_\_\_\_\_  
 EXIT DEVICE \_\_\_\_\_

MANUFACTURER \_\_\_\_\_  
 TEMPLATE NO. \_\_\_\_\_  
 FUNCTION NO. \_\_\_\_\_

NOTE: \* EXIT DEVICE BACK-SET SHALL BE GIVEN AS THE DISTANCE FROM C-L OF DEVICE TO C-L OF DOOR THICKNESS AT LOCK STILE UNLESS OTHERWISE NOTED.

### INACTIVE

#### STRIKES

- 1-1/4 X 4-7/8" ASA  
 1-1/8 X 2-3/4" LIP  
 1-1/8 X 2-3/4" D-BOLT

DUSTBOX

OTHER \_\_\_\_\_  
 MFG. \_\_\_\_\_  
 TEMP. \_\_\_\_\_

#### FLUSH BOLTS

MFG. \_\_\_\_\_  
 TEMP. NO. \_\_\_\_\_  
 CORNER PRE \_\_\_\_\_

#### 3 degree BEVELS

- Lock Edge  
 Hinge Edge

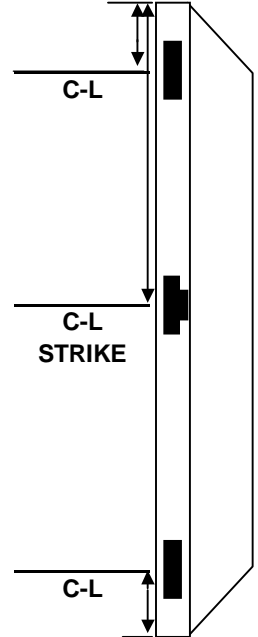

LIABILITY FOR MACHINING ACCURACY WILL BE ASSUMED ONLY UPON RECEIPT OF TEMPLATE, COMPLETED LYNDEN DOOR DETAIL SHEETS AND PHYSICAL SAMPLES AS REQUIRED.

SPEC. NO.

SPEC. NO.

## Fenestra 6'8" Locations

2077 MAIN STREET P.O. BOX 528 LYNDEN, WA 98264  
 PH (360)354.5676 FAX (360)318-8687

CUSTOMER \_\_\_\_\_  
 P. O. NUMBER \_\_\_\_\_

PAGE \_\_\_\_\_ OF \_\_\_\_\_  
 DATE \_\_\_\_\_  
 DRAWN BY \_\_\_\_\_

**Note: Any and all changes must be submitted to Lynden Door in writing. No verbal changes will be accepted. Accuracy of information is the responsibility of the customer.**

### HINGE

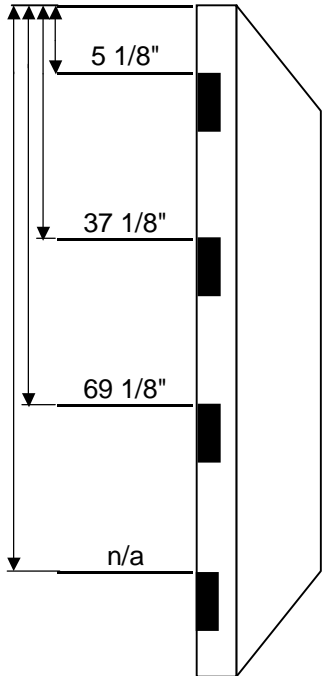

#### HINGES

SIZE 4 1/2"  
 BACKSET 1/4"  
 THICKNESS .134"  
 PIVOT \_\_\_\_\_  
 TEMPLATE NO. \_\_\_\_\_

#### HINGE CORNERS

- 1/4" Radius
- 5/8" Radius
- Square

#### 3 degree BEVELS

- Lock Edge
- Hinge Edge

**NOTE:** WHEN WIRE CHASE IS REQUIRED, DESIGNATE HINGE TO RECEIVE WIRE WITH AN "X"

### ACTIVE

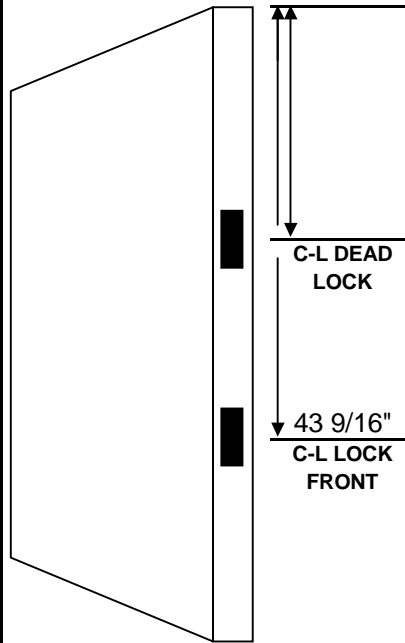

#### LOCKS / EXIT DEVICES

	BORED LOCK	DEAD LOCK
FACE BORE	_____	_____
BOLT BORE	_____	_____
BACKSET	_____	_____
F-P THICKNESS	_____	_____
F-PLATE WIDTH	_____	_____
F-P HEIGHT	_____	_____

#### CORNERS

- 1/4" Radius
- 5/8" Radius
- Square

MORTISE LOCK \_\_\_\_\_  
 CARD LOCK \_\_\_\_\_  
 EXIT DEVICE \_\_\_\_\_

MANUFACTURER \_\_\_\_\_  
 TEMPLATE NO. \_\_\_\_\_  
 FUNCTION NO. \_\_\_\_\_

**NOTE:** \* EXIT DEVICE BACK-SET SHALL BE GIVEN AS THE DISTANCE FROM C-L OF DEVICE TO C-L OF DOOR THICKNESS AT LOCK STILE UNLESS OTHERWISE NOTED.

### INACTIVE

#### STRIKES

- 1-1/4 X 4-7/8" ASA
- 1-1/8 X 2-3/4" LIP
- 1-1/8 X 2-3/4" D-BOLT

DUSTBOX

OTHER \_\_\_\_\_  
 MFG. \_\_\_\_\_  
 TEMP. \_\_\_\_\_

#### FLUSH BOLTS

MFG. \_\_\_\_\_  
 TEMP. NO. \_\_\_\_\_  
 CORNER PRE \_\_\_\_\_

#### 3 degree BEVELS

- Lock Edge
- Hinge Edge

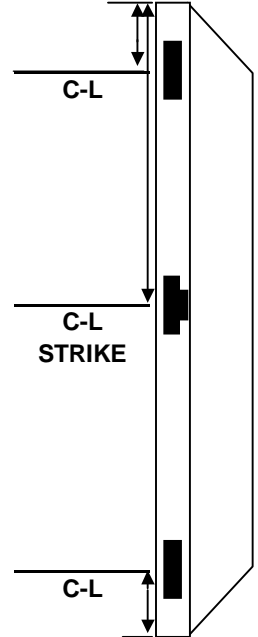

LIABILITY FOR MACHINING ACCURACY WILL BE ASSUMED ONLY UPON RECEIPT OF TEMPLATE, COMPLETED LYNDEN DOOR DETAIL SHEETS AND PHYSICAL SAMPLES AS REQUIRED.

SPEC. NO.

SPEC. NO.

## Fenestra 7'0" Locations

2077 MAIN STREET P.O. BOX 528 LYNDEN, WA 98264  
 PH (360)354.5676 FAX (360)318-8687

CUSTOMER \_\_\_\_\_  
 P. O. NUMBER \_\_\_\_\_

PAGE \_\_\_\_\_ OF \_\_\_\_\_  
 DATE \_\_\_\_\_  
 DRAWN BY \_\_\_\_\_

**Note: Any and all changes must be submitted to Lynden Door in writing. No verbal changes will be accepted. Accuracy of information is the responsibility of the customer.**

### HINGE

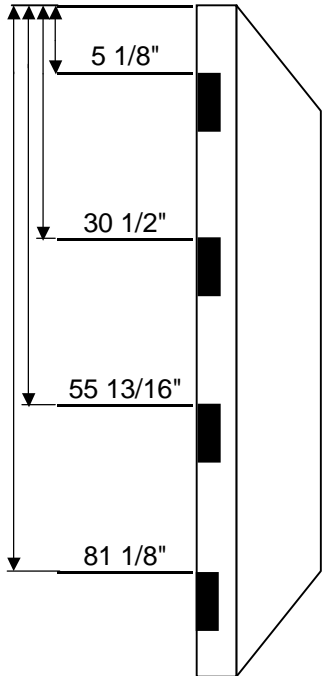

#### HINGES

SIZE 4 1/2"  
 BACKSET 1/4"  
 THICKNESS .134"  
 PIVOT \_\_\_\_\_  
 TEMPLATE NO. \_\_\_\_\_

#### HINGE CORNERS

- 1/4" Radius
- 5/8" Radius
- Square

#### 3 degree BEVELS

- Lock Edge
- Hinge Edge

**NOTE:** WHEN WIRE CHASE IS REQUIRED, DESIGNATE HINGE TO RECEIVE WIRE WITH AN "X"

### ACTIVE

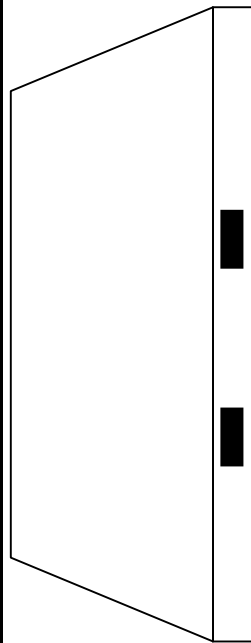

#### LOCKS / EXIT DEVICES

	BORED LOCK	DEAD LOCK
FACE BORE	_____	_____
BOLT BORE	_____	_____
BACKSET	_____	_____
F-P THICKNESS	_____	_____
F-PLATE WIDTH	_____	_____
F-P HEIGHT	_____	_____

#### CORNERS

- 1/4" Radius
- 5/8" Radius
- Square

MORTISE LOCK \_\_\_\_\_  
 CARD LOCK \_\_\_\_\_  
 EXIT DEVICE \_\_\_\_\_

MANUFACTURER \_\_\_\_\_  
 TEMPLATE NO. \_\_\_\_\_  
 FUNCTION NO. \_\_\_\_\_

**NOTE:** \* EXIT DEVICE BACK-SET SHALL BE GIVEN AS THE DISTANCE FROM C-L OF DEVICE TO C-L OF DOOR THICKNESS AT LOCK STILE UNLESS OTHERWISE NOTED.

### INACTIVE

#### STRIKES

- 1-1/4 X 4-7/8" ASA
- 1-1/8 X 2-3/4" LIP
- 1-1/8 X 2-3/4" D-BOLT

DUSTBOX

OTHER \_\_\_\_\_  
 MFG. \_\_\_\_\_  
 TEMP. \_\_\_\_\_

#### FLUSH BOLTS

MFG. \_\_\_\_\_  
 TEMP. NO. \_\_\_\_\_  
 CORNER PRE \_\_\_\_\_

#### 3 degree BEVELS

- Lock Edge
- Hinge Edge

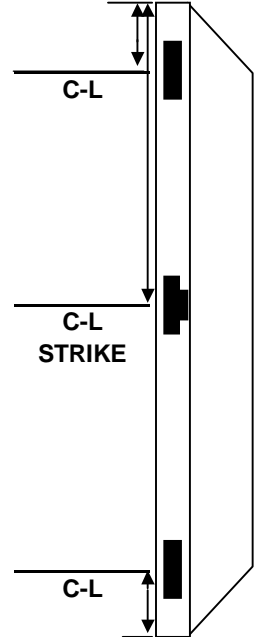

LIABILITY FOR MACHINING ACCURACY WILL BE ASSUMED ONLY UPON RECEIPT OF TEMPLATE, COMPLETED LYNDEN DOOR DETAIL SHEETS AND PHYSICAL SAMPLES AS REQUIRED.

SPEC. NO.

SPEC. NO.

## Fenestra 8'0" Locations

2077 MAIN STREET P.O. BOX 528 LYNDEN, WA 98264  
 PH (360)354.5676 FAX (360)318-8687

CUSTOMER \_\_\_\_\_  
 P. O. NUMBER \_\_\_\_\_

PAGE \_\_\_\_\_ OF \_\_\_\_\_  
 DATE \_\_\_\_\_  
 DRAWN BY \_\_\_\_\_

**Note: Any and all changes must be submitted to Lynden Door in writing. No verbal changes will be accepted. Accuracy of information is the responsibility of the customer.**

### HINGE

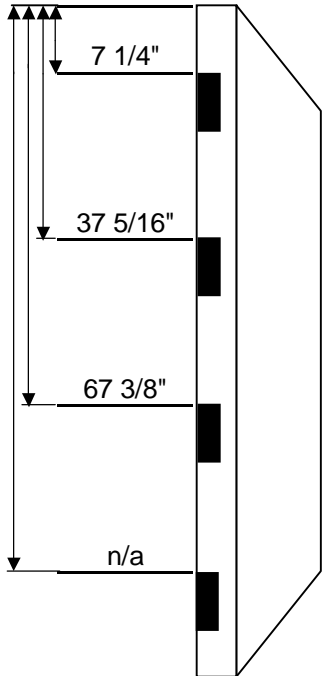

#### HINGES

SIZE 4 1/2"  
 BACKSET 1/4"  
 THICKNESS .134"  
 PIVOT \_\_\_\_\_  
 TEMPLATE NO. \_\_\_\_\_

#### HINGE CORNERS

- 1/4" Radius  
 5/8" Radius  
 Square

#### 3 degree BEVELS

- Lock Edge  
 Hinge Edge

**NOTE:** WHEN WIRE CHASE IS REQUIRED, DESIGNATE HINGE TO RECEIVE WIRE WITH AN "X"

### ACTIVE

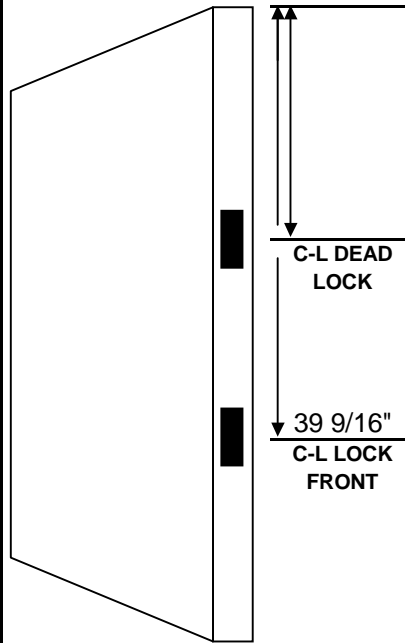

#### LOCKS / EXIT DEVICES

	BORED LOCK	DEAD LOCK
FACE BORE	_____	_____
BOLT BORE	_____	_____
BACKSET	_____	_____
F-P THICKNESS	_____	_____
F-PLATE WIDTH	_____	_____
F-P HEIGHT	_____	_____

#### CORNERS

- 1/4" Radius   
 5/8" Radius   
 Square

MORTISE LOCK \_\_\_\_\_  
 CARD LOCK \_\_\_\_\_  
 EXIT DEVICE \_\_\_\_\_

MANUFACTURER \_\_\_\_\_  
 TEMPLATE NO. \_\_\_\_\_  
 FUNCTION NO. \_\_\_\_\_

**NOTE:** \* EXIT DEVICE BACK-SET SHALL BE GIVEN AS THE DISTANCE FROM C-L OF DEVICE TO C-L OF DOOR THICKNESS AT LOCK STILE UNLESS OTHERWISE NOTED.

### INACTIVE

#### STRIKES

- 1-1/4 X 4-7/8" ASA  
 1-1/8 X 2-3/4" LIP  
 1-1/8 X 2-3/4" D-BOLT

DUSTBOX

OTHER \_\_\_\_\_  
 MFG. \_\_\_\_\_  
 TEMP. \_\_\_\_\_

#### FLUSH BOLTS

MFG. \_\_\_\_\_  
 TEMP. NO. \_\_\_\_\_  
 CORNER PRE \_\_\_\_\_

#### 3 degree BEVELS

- Lock Edge  
 Hinge Edge

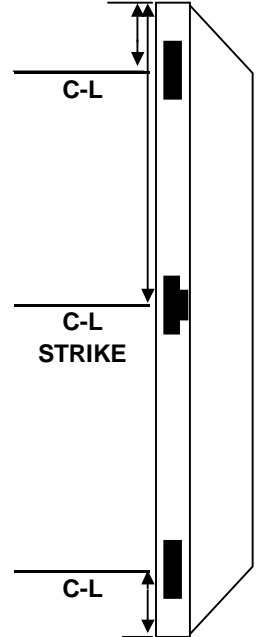

LIABILITY FOR MACHINING ACCURACY WILL BE ASSUMED ONLY UPON RECEIPT OF TEMPLATE, COMPLETED LYNDEN DOOR DETAIL SHEETS AND PHYSICAL SAMPLES AS REQUIRED.

SPEC. NO.

## Kewanee 6'8" Locations

SPEC. NO.



2077 MAIN STREET P.O. BOX 528 LYNDEN, WA 98264  
 PH (360)354.5676 FAX (360)318-8687

CUSTOMER \_\_\_\_\_  
 P. O. NUMBER \_\_\_\_\_

PAGE \_\_\_\_\_ OF \_\_\_\_\_  
 DATE \_\_\_\_\_  
 DRAWN BY \_\_\_\_\_

**Note: Any and all changes must be submitted to Lynden Door in writing. No verbal changes will be accepted. Accuracy of information is the responsibility of the customer.**

### HINGE

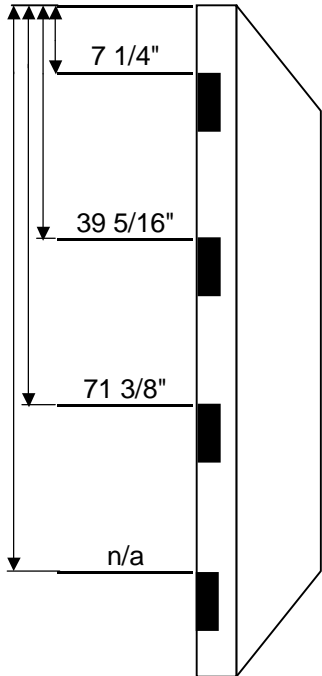

#### HINGES

SIZE 4 1/2"  
 BACKSET 1/4"  
 THICKNESS .134"  
 PIVOT \_\_\_\_\_  
 TEMPLATE NO. \_\_\_\_\_

#### HINGE CORNERS

- 1/4" Radius
- 5/8" Radius
- Square

#### 3 degree BEVELS

- Lock Edge
- Hinge Edge

**NOTE:** WHEN WIRE CHASE IS REQUIRED, DESIGNATE HINGE TO RECEIVE WIRE WITH AN "X"

### ACTIVE

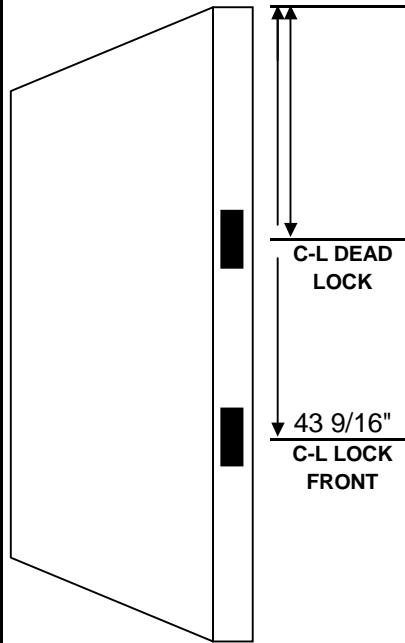

#### LOCKS / EXIT DEVICES

	BORED LOCK	DEAD LOCK
FACE BORE	_____	_____
BOLT BORE	_____	_____
BACKSET	_____	_____
F-P THICKNESS	_____	_____
F-PLATE WIDTH	_____	_____
F-P HEIGHT	_____	_____

#### CORNERS

- 1/4" Radius
- 5/8" Radius
- Square

MORTISE LOCK \_\_\_\_\_  
 CARD LOCK \_\_\_\_\_  
 EXIT DEVICE \_\_\_\_\_

MANUFACTURER \_\_\_\_\_  
 TEMPLATE NO. \_\_\_\_\_  
 FUNCTION NO. \_\_\_\_\_

**NOTE:** \* EXIT DEVICE BACK-SET SHALL BE GIVEN AS THE DISTANCE FROM C-L OF DEVICE TO C-L OF DOOR THICKNESS AT LOCK STILE UNLESS OTHERWISE NOTED.

### INACTIVE

#### STRIKES

- 1-1/4 X 4-7/8" ASA
- 1-1/8 X 2-3/4" LIP
- 1-1/8 X 2-3/4" D-BOLT

DUSTBOX

OTHER \_\_\_\_\_  
 MFG. \_\_\_\_\_  
 TEMP. \_\_\_\_\_

#### FLUSH BOLTS

MFG. \_\_\_\_\_  
 TEMP. NO. \_\_\_\_\_  
 CORNER PRE \_\_\_\_\_

#### 3 degree BEVELS

- Lock Edge
- Hinge Edge

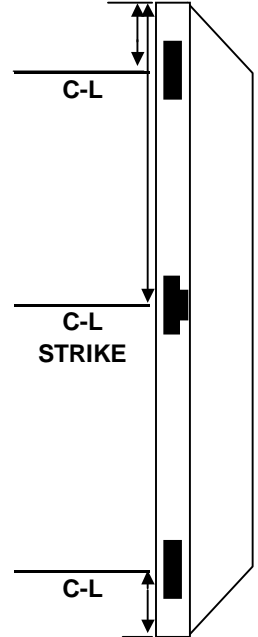

LIABILITY FOR MACHINING ACCURACY WILL BE ASSUMED ONLY UPON RECEIPT OF TEMPLATE, COMPLETED LYNDEN DOOR DETAIL SHEETS AND PHYSICAL SAMPLES AS REQUIRED.

SPEC. NO.

SPEC. NO.

## Kewanee 7'0" Locations

2077 MAIN STREET P.O. BOX 528 LYNDEN, WA 98264  
 PH (360)354.5676 FAX (360)318-8687

CUSTOMER \_\_\_\_\_  
 P. O. NUMBER \_\_\_\_\_

PAGE \_\_\_\_\_ OF \_\_\_\_\_  
 DATE \_\_\_\_\_  
 DRAWN BY \_\_\_\_\_

**Note: Any and all changes must be submitted to Lynden Door in writing. No verbal changes will be accepted. Accuracy of information is the responsibility of the customer.**

### HINGE

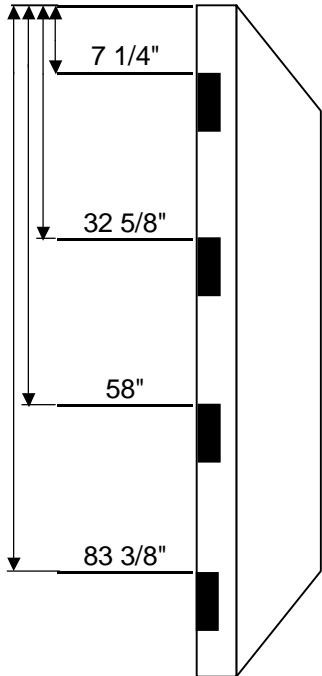

#### HINGES

SIZE 4 1/2"  
 BACKSET 1/4"  
 THICKNESS .134"  
 PIVOT \_\_\_\_\_  
 TEMPLATE NO. \_\_\_\_\_

#### HINGE CORNERS

- 1/4" Radius  
 5/8" Radius  
 Square

#### 3 degree BEVELS

- Lock Edge  
 Hinge Edge

**NOTE:** WHEN WIRE CHASE IS REQUIRED, DESIGNATE HINGE TO RECEIVE WIRE WITH AN "X"

### ACTIVE

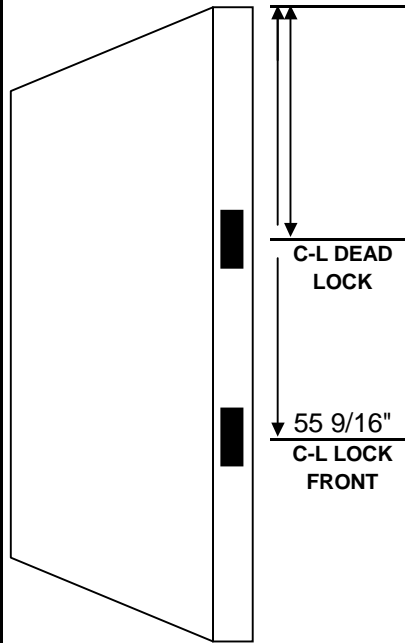

#### LOCKS / EXIT DEVICES

	BORED LOCK	DEAD LOCK
FACE BORE	_____	_____
BOLT BORE	_____	_____
BACKSET	_____	_____
F-P THICKNESS	_____	_____
F-PLATE WIDTH	_____	_____
F-P HEIGHT	_____	_____

#### CORNERS

- 1/4" Radius   
 5/8" Radius   
 Square

MORTISE LOCK \_\_\_\_\_  
 CARD LOCK \_\_\_\_\_  
 EXIT DEVICE \_\_\_\_\_

MANUFACTURER \_\_\_\_\_  
 TEMPLATE NO. \_\_\_\_\_  
 FUNCTION NO. \_\_\_\_\_

**NOTE:** \* EXIT DEVICE BACK-SET SHALL BE GIVEN AS THE DISTANCE FROM C-L OF DEVICE TO C-L OF DOOR THICKNESS AT LOCK STILE UNLESS OTHERWISE NOTED.

### INACTIVE

#### STRIKES

- 1-1/4 X 4-7/8" ASA  
 1-1/8 X 2-3/4" LIP  
 1-1/8 X 2-3/4" D-BOLT

DUSTBOX

OTHER \_\_\_\_\_  
 MFG. \_\_\_\_\_  
 TEMP. \_\_\_\_\_

#### FLUSH BOLTS

MFG. \_\_\_\_\_  
 TEMP. NO. \_\_\_\_\_  
 CORNER PRE \_\_\_\_\_

#### 3 degree BEVELS

- Lock Edge  
 Hinge Edge

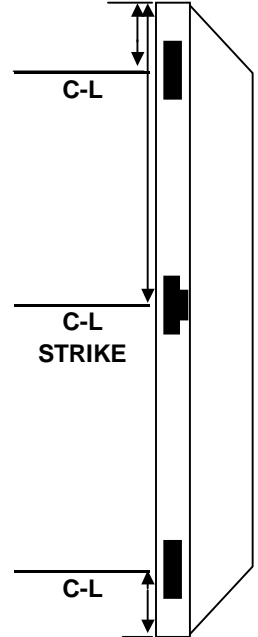

LIABILITY FOR MACHINING ACCURACY WILL BE ASSUMED ONLY UPON RECEIPT OF TEMPLATE, COMPLETED LYNDEN DOOR DETAIL SHEETS AND PHYSICAL SAMPLES AS REQUIRED.

SPEC. NO.

SPEC. NO.

## Kewanee 8'0" Locations

2077 MAIN STREET P.O. BOX 528 LYNDEN, WA 98264  
 PH (360)354.5676 FAX (360)318-8687

 CUSTOMER \_\_\_\_\_  
 P. O. NUMBER \_\_\_\_\_

 DATE \_\_\_\_\_  
 DRAWN BY \_\_\_\_\_

**Note: Any and all changes must be submitted to Lynden Door in writing. No verbal changes will be accepted. Accuracy of information is the responsibility of the customer.**

### HINGE

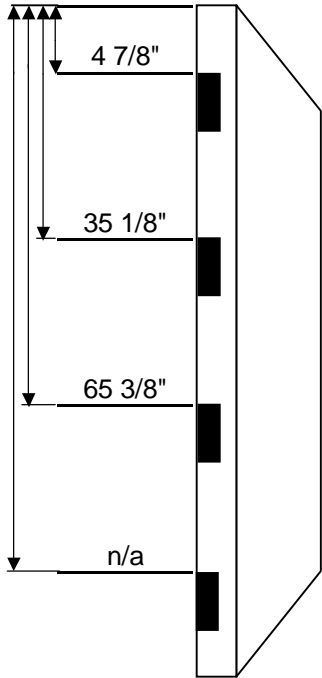

#### HINGES

 SIZE 4 1/2"  
 BACKSET 1/4"  
 THICKNESS .134"  
 PIVOT \_\_\_\_\_  
 TEMPLATE NO. \_\_\_\_\_

#### HINGE CORNERS

- 1/4" Radius  
 5/8" Radius  
 Square

#### 3 degree BEVELS

- Lock Edge  
 Hinge Edge

**NOTE:** WHEN WIRE CHASE IS REQUIRED, DESIGNATE HINGE TO RECEIVE WIRE WITH AN "X"

### ACTIVE

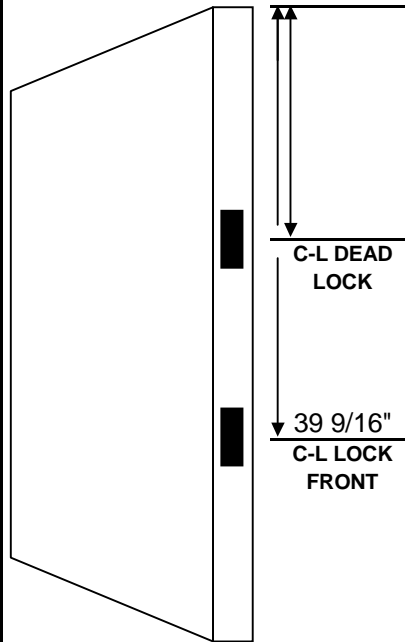

#### LOCKS / EXIT DEVICES

	BORED LOCK	DEAD LOCK
FACE BORE	_____	_____
BOLT BORE	_____	_____
BACKSET	_____	_____
F-P THICKNESS	_____	_____
F-PLATE WIDTH	_____	_____
F-P HEIGHT	_____	_____

#### CORNERS

- 1/4" Radius   
 5/8" Radius   
 Square

MORTISE LOCK \_\_\_\_\_  
 CARD LOCK \_\_\_\_\_  
 EXIT DEVICE \_\_\_\_\_

MANUFACTURER \_\_\_\_\_  
 TEMPLATE NO. \_\_\_\_\_  
 FUNCTION NO. \_\_\_\_\_

**NOTE:** \* EXIT DEVICE BACK-SET SHALL BE GIVEN AS THE DISTANCE FROM C-L OF DEVICE TO C-L OF DOOR THICKNESS AT LOCK STILE UNLESS OTHERWISE NOTED.

### INACTIVE

#### STRIKES

- 1-1/4 X 4-7/8" ASA  
 1-1/8 X 2-3/4" LIP  
 1-1/8 X 2-3/4" D-BOLT

DUSTBOX

OTHER \_\_\_\_\_  
 MFG. \_\_\_\_\_  
 TEMP. \_\_\_\_\_

#### FLUSH BOLTS

MFG. \_\_\_\_\_  
 TEMP. NO. \_\_\_\_\_  
 CORNER PRE \_\_\_\_\_

#### 3 degree BEVELS

- Lock Edge  
 Hinge Edge

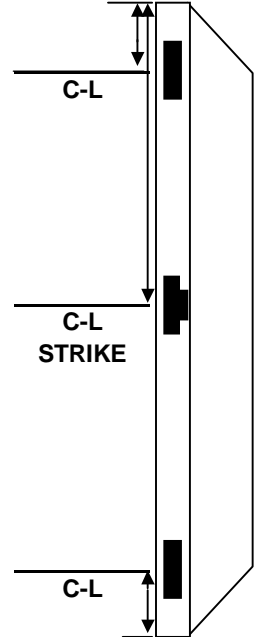

LIABILITY FOR MACHINING ACCURACY WILL BE ASSUMED ONLY UPON RECEIPT OF TEMPLATE, COMPLETED LYNDEN DOOR DETAIL SHEETS AND PHYSICAL SAMPLES AS REQUIRED.

SPEC. NO.

## Mesker 6'8" Locations

SPEC. NO.

2077 MAIN STREET P.O. BOX 528 LYNDEN, WA 98264  
 PH (360)354.5676 FAX (360)318-8687

 CUSTOMER \_\_\_\_\_  
 P. O. NUMBER \_\_\_\_\_

 DATE \_\_\_\_\_  
 DRAWN BY \_\_\_\_\_

**Note: Any and all changes must be submitted to Lynden Door in writing. No verbal changes will be accepted. Accuracy of information is the responsibility of the customer.**

### HINGE

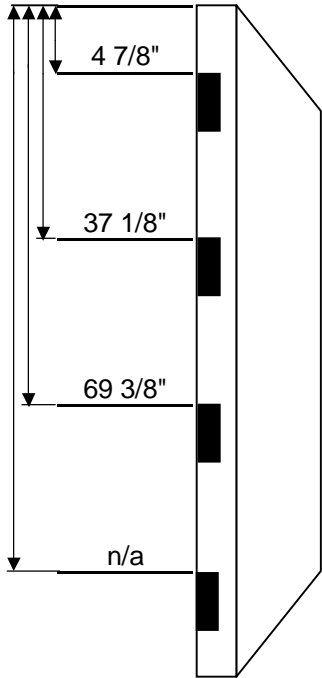

#### HINGES

 SIZE 4 1/2"  
 BACKSET 1/4"  
 THICKNESS .134"  
 PIVOT \_\_\_\_\_  
 TEMPLATE NO. \_\_\_\_\_

#### HINGE CORNERS

- 1/4" Radius
- 5/8" Radius
- Square

#### 3 degree BEVELS

- Lock Edge
- Hinge Edge

**NOTE:** WHEN WIRE CHASE IS REQUIRED, DESIGNATE HINGE TO RECEIVE WIRE WITH AN "X"

### ACTIVE

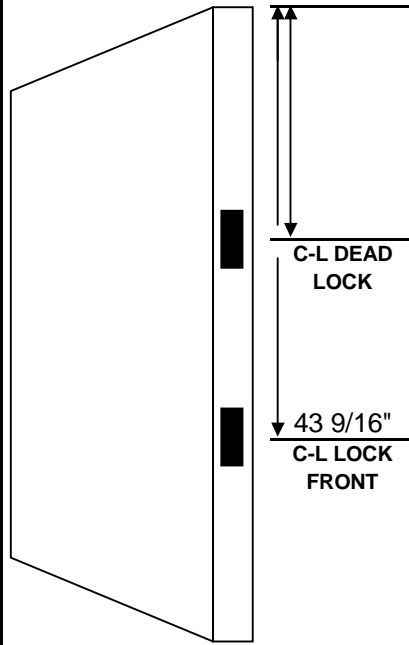

#### LOCKS / EXIT DEVICES

	BORED LOCK	DEAD LOCK
FACE BORE	_____	_____
BOLT BORE	_____	_____
BACKSET	_____	_____
F-P THICKNESS	_____	_____
F-PLATE WIDTH	_____	_____
F-P HEIGHT	_____	_____

#### CORNERS

- 1/4" Radius
- 5/8" Radius
- Square

 MORTISE LOCK \_\_\_\_\_  
 CARD LOCK \_\_\_\_\_  
 EXIT DEVICE \_\_\_\_\_

 MANUFACTURER \_\_\_\_\_  
 TEMPLATE NO. \_\_\_\_\_  
 FUNCTION NO. \_\_\_\_\_

**NOTE:** \* EXIT DEVICE BACK-SET SHALL BE GIVEN AS THE DISTANCE FROM C-L OF DEVICE TO C-L OF DOOR THICKNESS AT LOCK STILE UNLESS OTHERWISE NOTED.

### INACTIVE

#### STRIKES

- 1-1/4 X 4-7/8" ASA
- 1-1/8 X 2-3/4" LIP
- 1-1/8 X 2-3/4" D-BOLT

 DUSTBOX

 OTHER \_\_\_\_\_  
 MFG. \_\_\_\_\_  
 TEMP. \_\_\_\_\_

#### FLUSH BOLTS

 MFG. \_\_\_\_\_  
 TEMP. NO. \_\_\_\_\_  
 CORNER PRE \_\_\_\_\_

#### 3 degree BEVELS

- Lock Edge
- Hinge Edge

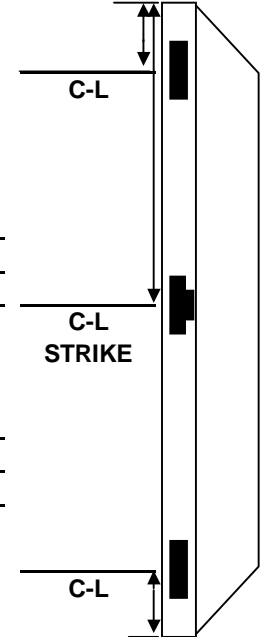

LIABILITY FOR MACHINING ACCURACY WILL BE ASSUMED ONLY UPON RECEIPT OF TEMPLATE, COMPLETED LYNDEN DOOR DETAIL SHEETS AND PHYSICAL SAMPLES AS REQUIRED.

SPEC. NO.

## Mesker 7'0" Locations

SPEC. NO.

2077 MAIN STREET P.O. BOX 528 LYNDEN, WA 98264  
 PH (360)354.5676 FAX (360)318-8687

CUSTOMER \_\_\_\_\_  
 P. O. NUMBER \_\_\_\_\_

PAGE \_\_\_\_\_ OF \_\_\_\_\_  
 DATE \_\_\_\_\_  
 DRAWN BY \_\_\_\_\_

**Note: Any and all changes must be submitted to Lynden Door in writing. No verbal changes will be accepted. Accuracy of information is the responsibility of the customer.**

### HINGE

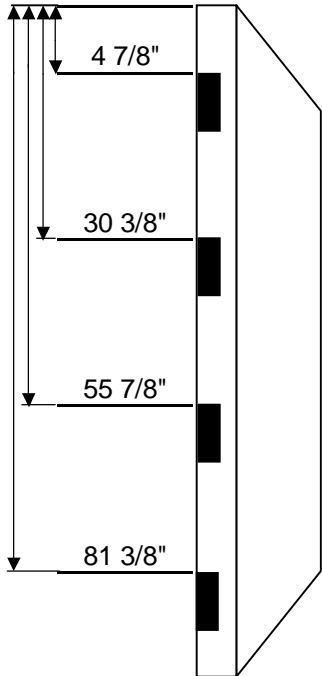

#### HINGES

SIZE 4 1/2"  
 BACKSET 1/4"  
 THICKNESS .134"  
 PIVOT \_\_\_\_\_  
 TEMPLATE NO. \_\_\_\_\_

#### HINGE CORNERS

- 1/4" Radius
- 5/8" Radius
- Square

#### 3 degree BEVELS

- Lock Edge
- Hinge Edge

**NOTE:** WHEN WIRE CHASE IS REQUIRED, DESIGNATE HINGE TO RECEIVE WIRE WITH AN "X"

### ACTIVE

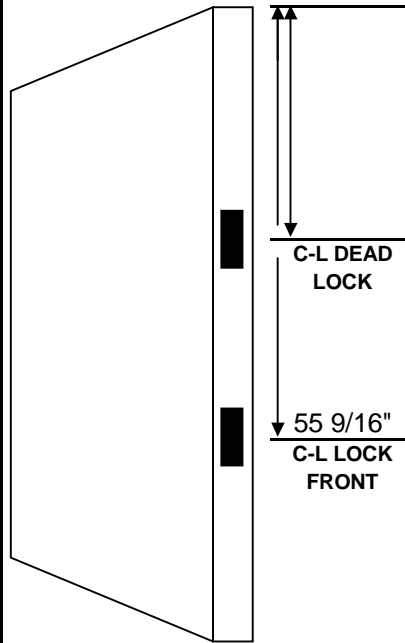

#### LOCKS / EXIT DEVICES

	BORED LOCK	DEAD LOCK
FACE BORE	_____	_____
BOLT BORE	_____	_____
BACKSET	_____	_____
F-P THICKNESS	_____	_____
F-PLATE WIDTH	_____	_____
F-P HEIGHT	_____	_____

#### CORNERS

- 1/4" Radius
- 5/8" Radius
- Square

MORTISE LOCK \_\_\_\_\_  
 CARD LOCK \_\_\_\_\_  
 EXIT DEVICE \_\_\_\_\_

MANUFACTURER \_\_\_\_\_  
 TEMPLATE NO. \_\_\_\_\_  
 FUNCTION NO. \_\_\_\_\_

**NOTE:** \* EXIT DEVICE BACK-SET SHALL BE GIVEN AS THE DISTANCE FROM C-L OF DEVICE TO C-L OF DOOR THICKNESS AT LOCK STILE UNLESS OTHERWISE NOTED.

### INACTIVE

#### STRIKES

- 1-1/4 X 4-7/8" ASA
- 1-1/8 X 2-3/4" LIP
- 1-1/8 X 2-3/4" D-BOLT

DUSTBOX

OTHER \_\_\_\_\_  
 MFG. \_\_\_\_\_  
 TEMP. \_\_\_\_\_

#### FLUSH BOLTS

MFG. \_\_\_\_\_  
 TEMP. NO. \_\_\_\_\_  
 CORNER PRE \_\_\_\_\_

#### 3 degree BEVELS

- Lock Edge
- Hinge Edge

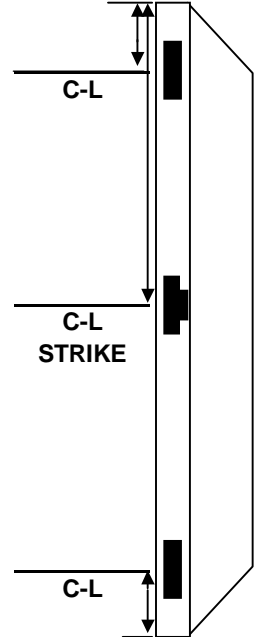

LIABILITY FOR MACHINING ACCURACY WILL BE ASSUMED ONLY UPON RECEIPT OF TEMPLATE, COMPLETED LYNDEN DOOR DETAIL SHEETS AND PHYSICAL SAMPLES AS REQUIRED.

SPEC. NO.

## Mesker 8'0" Locations

SPEC. NO.

2077 MAIN STREET P.O. BOX 528 LYNDEN, WA 98264  
 PH (360)354.5676 FAX (360)318-8687

CUSTOMER \_\_\_\_\_  
 P. O. NUMBER \_\_\_\_\_

PAGE \_\_\_\_\_ OF \_\_\_\_\_  
 DATE \_\_\_\_\_  
 DRAWN BY \_\_\_\_\_

**Note: Any and all changes must be submitted to Lynden Door in writing. No verbal changes will be accepted. Accuracy of information is the responsibility of the customer.**

### HINGE

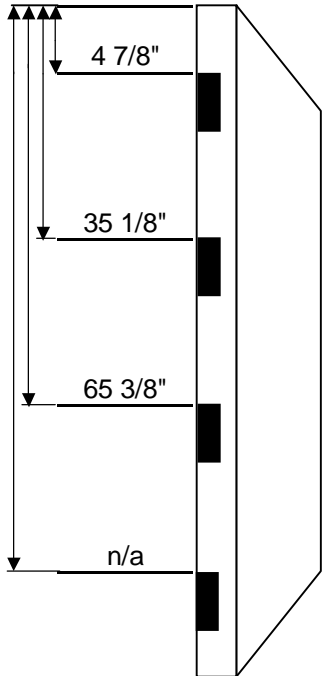

#### HINGES

SIZE 4 1/2"  
 BACKSET 1/4"  
 THICKNESS .134"  
 PIVOT \_\_\_\_\_  
 TEMPLATE NO. \_\_\_\_\_

#### HINGE CORNERS

- 1/4" Radius  
 5/8" Radius  
 Square

#### 3 degree BEVELS

- Lock Edge  
 Hinge Edge

**NOTE:** WHEN WIRE CHASE IS REQUIRED, DESIGNATE HINGE TO RECEIVE WIRE WITH AN "X"

### ACTIVE

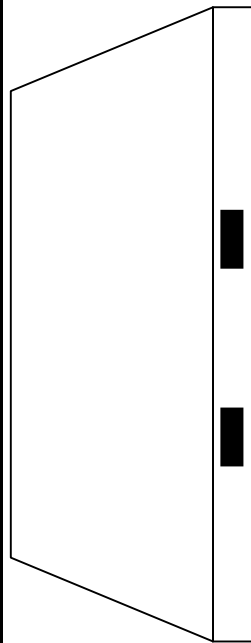

#### LOCKS / EXIT DEVICES

	BORED LOCK	DEAD LOCK
FACE BORE	_____	_____
BOLT BORE	_____	_____
BACKSET	_____	_____
F-P THICKNESS	_____	_____
F-PLATE WIDTH	_____	_____
F-P HEIGHT	_____	_____

#### CORNERS

- 1/4" Radius   
 5/8" Radius   
 Square

MORTISE LOCK \_\_\_\_\_  
 CARD LOCK \_\_\_\_\_  
 EXIT DEVICE \_\_\_\_\_

MANUFACTURER \_\_\_\_\_  
 TEMPLATE NO. \_\_\_\_\_  
 FUNCTION NO. \_\_\_\_\_

**NOTE:** \* EXIT DEVICE BACK-SET SHALL BE GIVEN AS THE DISTANCE FROM C-L OF DEVICE TO C-L OF DOOR THICKNESS AT LOCK STILE UNLESS OTHERWISE NOTED.

### INACTIVE

#### STRIKES

- 1-1/4 X 4-7/8" ASA  
 1-1/8 X 2-3/4" LIP  
 1-1/8 X 2-3/4" D-BOLT

DUSTBOX

OTHER \_\_\_\_\_  
 MFG. \_\_\_\_\_  
 TEMP. \_\_\_\_\_

#### FLUSH BOLTS

MFG. \_\_\_\_\_  
 TEMP. NO. \_\_\_\_\_  
 CORNER PRE \_\_\_\_\_

#### 3 degree BEVELS

- Lock Edge  
 Hinge Edge

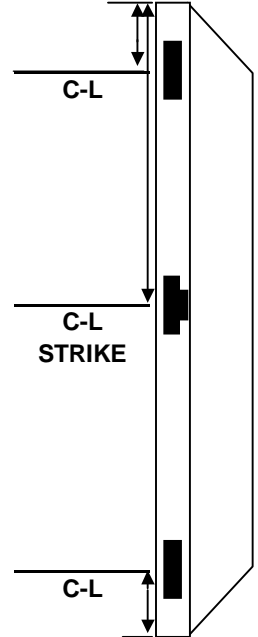

LIABILITY FOR MACHINING ACCURACY WILL BE ASSUMED ONLY UPON RECEIPT OF TEMPLATE, COMPLETED LYNDEN DOOR DETAIL SHEETS AND PHYSICAL SAMPLES AS REQUIRED.

SPEC. NO.

SPEC. NO.

## Pioneer 6'8" Locations

2077 MAIN STREET P.O. BOX 528 LYNDEN, WA 98264  
 PH (360)354.5676 FAX (360)318-8687

CUSTOMER \_\_\_\_\_  
 P. O. NUMBER \_\_\_\_\_

PAGE \_\_\_\_\_ OF \_\_\_\_\_  
 DATE \_\_\_\_\_  
 DRAWN BY \_\_\_\_\_

**Note: Any and all changes must be submitted to Lynden Door in writing. No verbal changes will be accepted. Accuracy of information is the responsibility of the customer.**

### HINGE

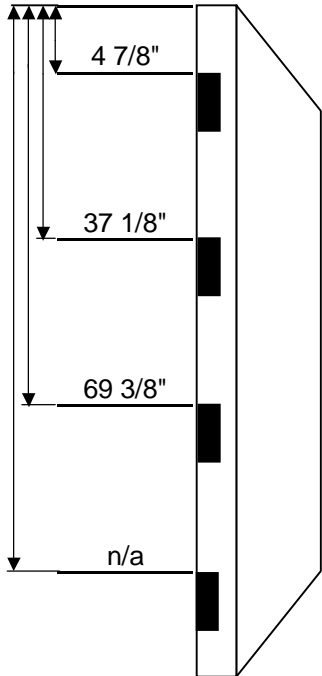

#### HINGES

SIZE 4 1/2"  
 BACKSET 1/4"  
 THICKNESS .134"  
 PIVOT \_\_\_\_\_  
 TEMPLATE NO. \_\_\_\_\_

#### HINGE CORNERS

- 1/4" Radius
- 5/8" Radius
- Square

#### 3 degree BEVELS

- Lock Edge
- Hinge Edge

**NOTE:** WHEN WIRE CHASE IS REQUIRED, DESIGNATE HINGE TO RECEIVE WIRE WITH AN "X"

### ACTIVE

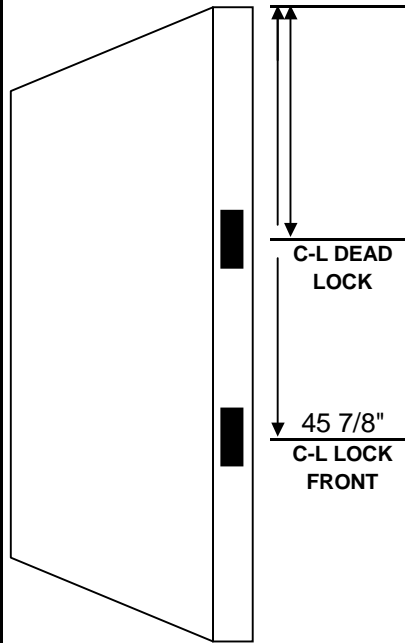

#### LOCKS / EXIT DEVICES

	BORED LOCK	DEAD LOCK
FACE BORE	_____	_____
BOLT BORE	_____	_____
BACKSET	_____	_____
F-P THICKNESS	_____	_____
F-PLATE WIDTH	_____	_____
F-P HEIGHT	_____	_____

#### CORNERS

- 1/4" Radius
- 5/8" Radius
- Square

MORTISE LOCK \_\_\_\_\_  
 CARD LOCK \_\_\_\_\_  
 EXIT DEVICE \_\_\_\_\_

MANUFACTURER \_\_\_\_\_  
 TEMPLATE NO. \_\_\_\_\_  
 FUNCTION NO. \_\_\_\_\_

**NOTE:** \* EXIT DEVICE BACK-SET SHALL BE GIVEN AS THE DISTANCE FROM C-L OF DEVICE TO C-L OF DOOR THICKNESS AT LOCK STILE UNLESS OTHERWISE NOTED.

### INACTIVE

#### STRIKES

- 1-1/4 X 4-7/8" ASA
- 1-1/8 X 2-3/4" LIP
- 1-1/8 X 2-3/4" D-BOLT

DUSTBOX

OTHER \_\_\_\_\_  
 MFG. \_\_\_\_\_  
 TEMP. \_\_\_\_\_

#### FLUSH BOLTS

MFG. \_\_\_\_\_  
 TEMP. NO. \_\_\_\_\_  
 CORNER PRE \_\_\_\_\_

#### 3 degree BEVELS

- Lock Edge
- Hinge Edge

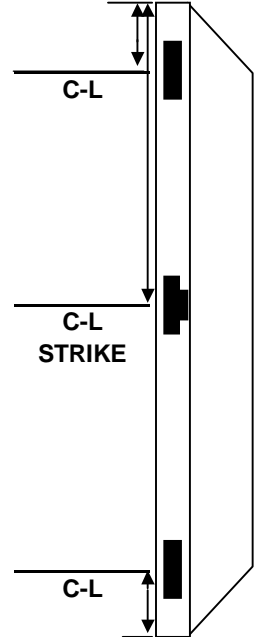

LIABILITY FOR MACHINING ACCURACY WILL BE ASSUMED ONLY UPON RECEIPT OF TEMPLATE, COMPLETED LYNDEN DOOR DETAIL SHEETS AND PHYSICAL SAMPLES AS REQUIRED.

SPEC. NO.

## Pioneer 7'0" Locations

SPEC. NO.

2077 MAIN STREET P.O. BOX 528 LYNDEN, WA 98264  
 PH (360)354.5676 FAX (360)318-8687

CUSTOMER \_\_\_\_\_  
 P. O. NUMBER \_\_\_\_\_

PAGE \_\_\_\_\_ OF \_\_\_\_\_  
 DATE \_\_\_\_\_  
 DRAWN BY \_\_\_\_\_

**Note: Any and all changes must be submitted to Lynden Door in writing. No verbal changes will be accepted. Accuracy of information is the responsibility of the customer.**

### HINGE

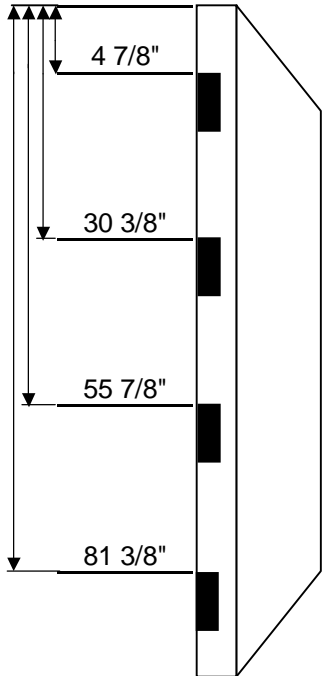

#### HINGES

SIZE 4 1/2"  
 BACKSET 1/4"  
 THICKNESS .134"  
 PIVOT \_\_\_\_\_  
 TEMPLATE NO. \_\_\_\_\_

#### HINGE CORNERS

- 1/4" Radius
- 5/8" Radius
- Square

#### 3 degree BEVELS

- Lock Edge
- Hinge Edge

**NOTE:** WHEN WIRE CHASE IS REQUIRED, DESIGNATE HINGE TO RECEIVE WIRE WITH AN "X"

### ACTIVE

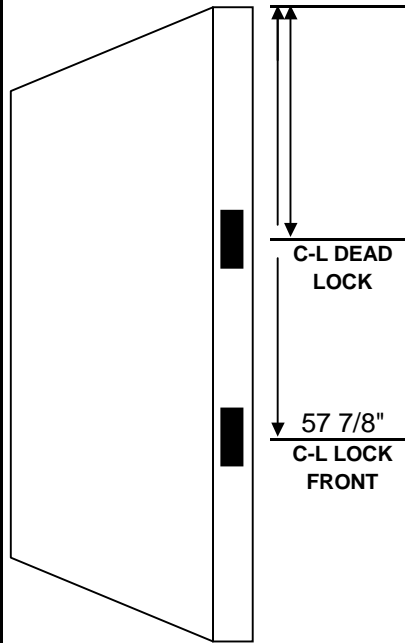

#### LOCKS / EXIT DEVICES

	BORED LOCK	DEAD LOCK
FACE BORE	_____	_____
BOLT BORE	_____	_____
BACKSET	_____	_____
F-P THICKNESS	_____	_____
F-PLATE WIDTH	_____	_____
F-P HEIGHT	_____	_____

#### CORNERS

- 1/4" Radius
- 5/8" Radius
- Square

MORTISE LOCK \_\_\_\_\_  
 CARD LOCK \_\_\_\_\_  
 EXIT DEVICE \_\_\_\_\_

MANUFACTURER \_\_\_\_\_  
 TEMPLATE NO. \_\_\_\_\_  
 FUNCTION NO. \_\_\_\_\_

**NOTE:** \* EXIT DEVICE BACK-SET SHALL BE GIVEN AS THE DISTANCE FROM C-L OF DEVICE TO C-L OF DOOR THICKNESS AT LOCK STILE UNLESS OTHERWISE NOTED.

### INACTIVE

#### STRIKES

- 1-1/4 X 4-7/8" ASA
- 1-1/8 X 2-3/4" LIP
- 1-1/8 X 2-3/4" D-BOLT

DUSTBOX

OTHER \_\_\_\_\_  
 MFG. \_\_\_\_\_  
 TEMP. \_\_\_\_\_

#### FLUSH BOLTS

MFG. \_\_\_\_\_  
 TEMP. NO. \_\_\_\_\_  
 CORNER PRE \_\_\_\_\_

#### 3 degree BEVELS

- Lock Edge
- Hinge Edge

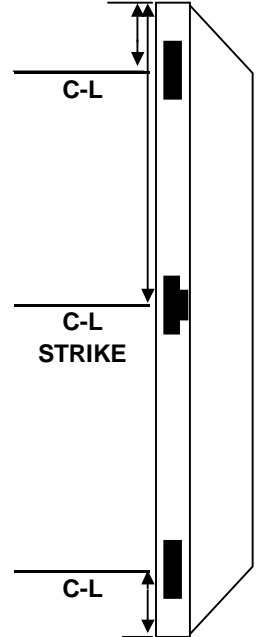

LIABILITY FOR MACHINING ACCURACY WILL BE ASSUMED ONLY UPON RECEIPT OF TEMPLATE, COMPLETED LYNDEN DOOR DETAIL SHEETS AND PHYSICAL SAMPLES AS REQUIRED.

SPEC. NO.

SPEC. NO.

## Pioneer 8'0" Locations



2077 MAIN STREET P.O. BOX 528 LYNDEN, WA 98264  
 PH (360)354.5676 FAX (360)318-8687

CUSTOMER \_\_\_\_\_  
 P. O. NUMBER \_\_\_\_\_

PAGE \_\_\_\_\_ OF \_\_\_\_\_  
 DATE \_\_\_\_\_  
 DRAWN BY \_\_\_\_\_

**Note: Any and all changes must be submitted to Lynden Door in writing. No verbal changes will be accepted. Accuracy of information is the responsibility of the customer.**

### HINGE

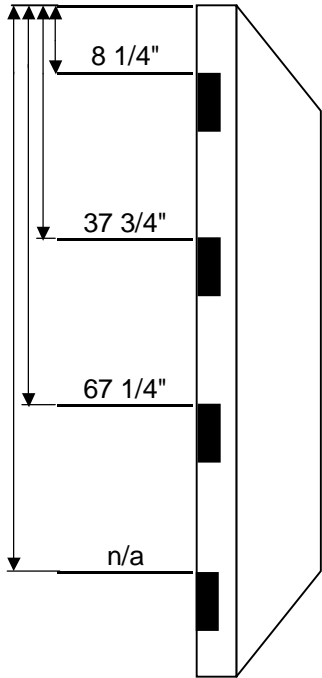

#### HINGES

SIZE 4 1/2"  
 BACKSET 1/4"  
 THICKNESS .134"  
 PIVOT \_\_\_\_\_  
 TEMPLATE NO. \_\_\_\_\_

#### HINGE CORNERS

- 1/4" Radius
- 5/8" Radius
- Square

#### 3 degree BEVELS

- Lock Edge
- Hinge Edge

**NOTE:** WHEN WIRE CHASE IS REQUIRED, DESIGNATE HINGE TO RECEIVE WIRE WITH AN "X"

### ACTIVE

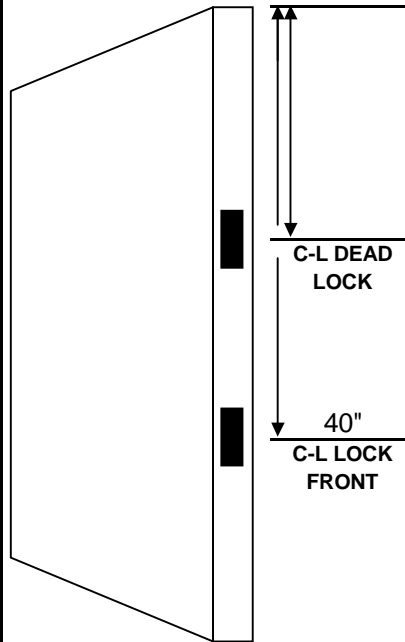

#### LOCKS / EXIT DEVICES

	BORED LOCK	DEAD LOCK
FACE BORE	_____	_____
BOLT BORE	_____	_____
BACKSET	_____	_____
F-P THICKNESS	_____	_____
F-PLATE WIDTH	_____	_____
F-P HEIGHT	_____	_____

#### CORNERS

- 1/4" Radius
- 5/8" Radius
- Square

MORTISE LOCK \_\_\_\_\_  
 CARD LOCK \_\_\_\_\_  
 EXIT DEVICE \_\_\_\_\_

MANUFACTURER \_\_\_\_\_  
 TEMPLATE NO. \_\_\_\_\_  
 FUNCTION NO. \_\_\_\_\_

**NOTE:** \* EXIT DEVICE BACK-SET SHALL BE GIVEN AS THE DISTANCE FROM C-L OF DEVICE TO C-L OF DOOR THICKNESS AT LOCK STILE UNLESS OTHERWISE NOTED.

### INACTIVE

#### STRIKES

- 1-1/4 X 4-7/8" ASA
- 1-1/8 X 2-3/4" LIP
- 1-1/8 X 2-3/4" D-BOLT

DUSTBOX

OTHER \_\_\_\_\_  
 MFG. \_\_\_\_\_  
 TEMP. \_\_\_\_\_

#### FLUSH BOLTS

MFG. \_\_\_\_\_  
 TEMP. NO. \_\_\_\_\_  
 CORNER PRE \_\_\_\_\_

#### 3 degree BEVELS

- Lock Edge
- Hinge Edge

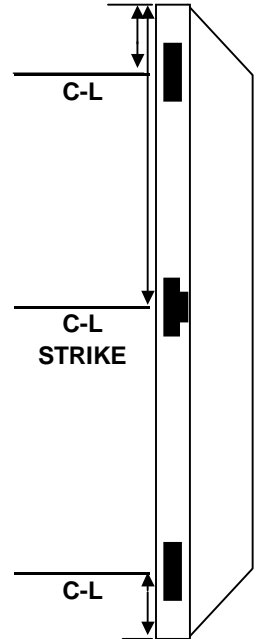

LIABILITY FOR MACHINING ACCURACY WILL BE ASSUMED ONLY UPON RECEIPT OF TEMPLATE, COMPLETED LYNDEN DOOR DETAIL SHEETS AND PHYSICAL SAMPLES AS REQUIRED.

SPEC. NO.

## Rediframe 6'8" Locations

SPEC. NO.

2077 MAIN STREET P.O. BOX 528 LYNDEN, WA 98264  
 PH (360)354.5676 FAX (360)318-8687

 CUSTOMER \_\_\_\_\_  
 P. O. NUMBER \_\_\_\_\_

 DATE \_\_\_\_\_  
 DRAWN BY \_\_\_\_\_

**Note: Any and all changes must be submitted to Lynden Door in writing. No verbal changes will be accepted. Accuracy of information is the responsibility of the customer.**

### HINGE

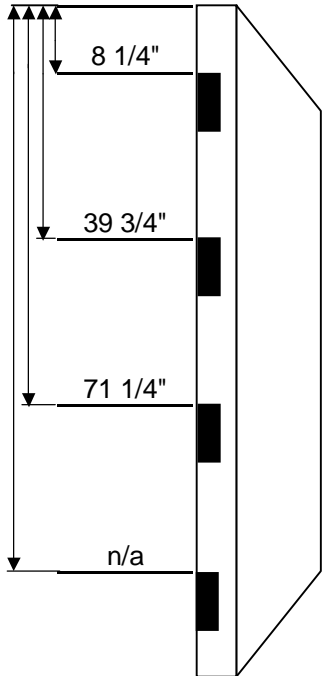

#### HINGES

 SIZE 4 1/2"  
 BACKSET 1/4"  
 THICKNESS .134"  
 PIVOT \_\_\_\_\_  
 TEMPLATE NO. \_\_\_\_\_

#### HINGE CORNERS

- 1/4" Radius  
 5/8" Radius  
 Square

#### 3 degree BEVELS

- Lock Edge  
 Hinge Edge

**NOTE:** WHEN WIRE CHASE IS REQUIRED, DESIGNATE HINGE TO RECEIVE WIRE WITH AN "X"

### ACTIVE

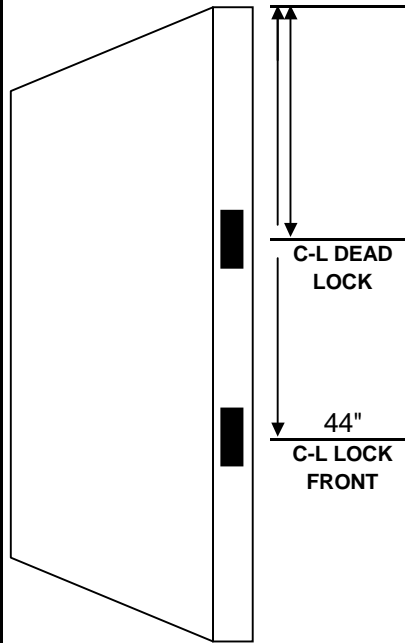

#### LOCKS / EXIT DEVICES

	BORED LOCK	DEAD LOCK
FACE BORE	_____	_____
BOLT BORE	_____	_____
BACKSET	_____	_____
F-P THICKNESS	_____	_____
F-PLATE WIDTH	_____	_____
F-P HEIGHT	_____	_____

#### CORNERS

- 1/4" Radius   
 5/8" Radius   
 Square

MORTISE LOCK \_\_\_\_\_  
 CARD LOCK \_\_\_\_\_  
 EXIT DEVICE \_\_\_\_\_

MANUFACTURER \_\_\_\_\_  
 TEMPLATE NO. \_\_\_\_\_  
 FUNCTION NO. \_\_\_\_\_

**NOTE:** \* EXIT DEVICE BACK-SET SHALL BE GIVEN AS THE DISTANCE FROM C-L OF DEVICE TO C-L OF DOOR THICKNESS AT LOCK STILE UNLESS OTHERWISE NOTED.

### INACTIVE

#### STRIKES

- 1-1/4 X 4-7/8" ASA  
 1-1/8 X 2-3/4" LIP  
 1-1/8 X 2-3/4" D-BOLT

DUSTBOX

OTHER \_\_\_\_\_  
 MFG. \_\_\_\_\_  
 TEMP. \_\_\_\_\_

#### FLUSH BOLTS

MFG. \_\_\_\_\_  
 TEMP. NO. \_\_\_\_\_  
 CORNER PRE \_\_\_\_\_

#### 3 degree BEVELS

- Lock Edge  
 Hinge Edge

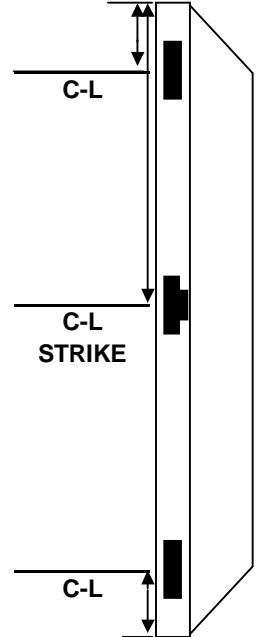

LIABILITY FOR MACHINING ACCURACY WILL BE ASSUMED ONLY UPON RECEIPT OF TEMPLATE, COMPLETED LYNDEN DOOR DETAIL SHEETS AND PHYSICAL SAMPLES AS REQUIRED.

SPEC. NO.

## Rediframe 7'0" Locations

SPEC. NO.

2077 MAIN STREET P.O. BOX 528 LYNDEN, WA 98264  
 PH (360)354.5676 FAX (360)318-8687

 CUSTOMER \_\_\_\_\_  
 P. O. NUMBER \_\_\_\_\_

 DATE \_\_\_\_\_  
 DRAWN BY \_\_\_\_\_

**Note: Any and all changes must be submitted to Lynden Door in writing. No verbal changes will be accepted. Accuracy of information is the responsibility of the customer.**

### HINGE

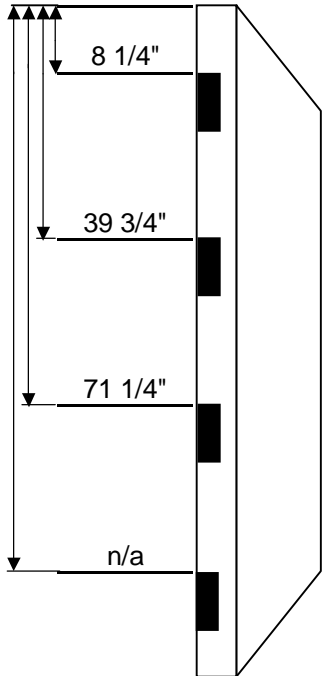

#### HINGES

 SIZE 4 1/2"  
 BACKSET 1/4"  
 THICKNESS .134"  
 PIVOT \_\_\_\_\_  
 TEMPLATE NO. \_\_\_\_\_

#### HINGE CORNERS

- 1/4" Radius  
 5/8" Radius  
 Square

#### 3 degree BEVELS

- Lock Edge  
 Hinge Edge

**NOTE:** WHEN WIRE CHASE IS REQUIRED, DESIGNATE HINGE TO RECEIVE WIRE WITH AN "X"

### ACTIVE

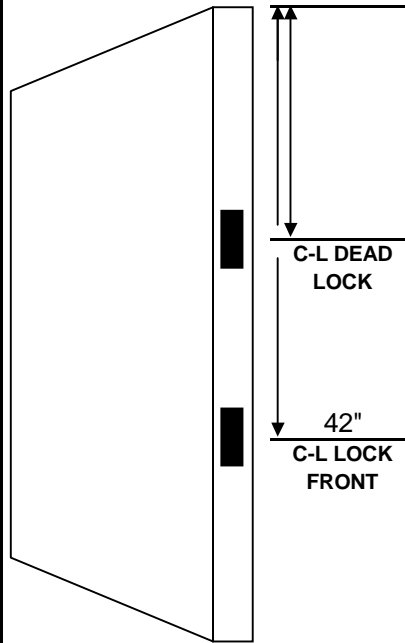

#### LOCKS / EXIT DEVICES

	BORED LOCK	DEAD LOCK
FACE BORE	_____	_____
BOLT BORE	_____	_____
BACKSET	_____	_____
F-P THICKNESS	_____	_____
F-PLATE WIDTH	_____	_____
F-P HEIGHT	_____	_____

#### CORNERS

- 1/4" Radius   
 5/8" Radius   
 Square

MORTISE LOCK \_\_\_\_\_  
 CARD LOCK \_\_\_\_\_  
 EXIT DEVICE \_\_\_\_\_

MANUFACTURER \_\_\_\_\_  
 TEMPLATE NO. \_\_\_\_\_  
 FUNCTION NO. \_\_\_\_\_

**NOTE:** \* EXIT DEVICE BACK-SET SHALL BE GIVEN AS THE DISTANCE FROM C-L OF DEVICE TO C-L OF DOOR THICKNESS AT LOCK STILE UNLESS OTHERWISE NOTED.

### INACTIVE

#### STRIKES

- 1-1/4 X 4-7/8" ASA  
 1-1/8 X 2-3/4" LIP  
 1-1/8 X 2-3/4" D-BOLT

DUSTBOX

OTHER \_\_\_\_\_  
 MFG. \_\_\_\_\_  
 TEMP. \_\_\_\_\_

#### FLUSH BOLTS

MFG. \_\_\_\_\_  
 TEMP. NO. \_\_\_\_\_  
 CORNER PRE \_\_\_\_\_

#### 3 degree BEVELS

- Lock Edge  
 Hinge Edge

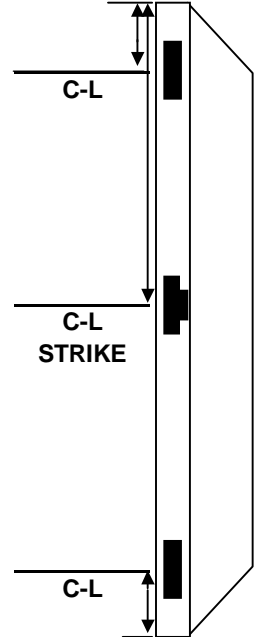

LIABILITY FOR MACHINING ACCURACY WILL BE ASSUMED ONLY UPON RECEIPT OF TEMPLATE, COMPLETED LYNDEN DOOR DETAIL SHEETS AND PHYSICAL SAMPLES AS REQUIRED.

SPEC. NO.

# Rediframe 7'0" Reversible Locations

SPEC. NO.

2077 MAIN STREET P.O. BOX 528 LYNDEN, WA 98264  
 PH (360)354.5676 FAX (360)318-8687

CUSTOMER \_\_\_\_\_  
 P. O. NUMBER \_\_\_\_\_

PAGE \_\_\_\_\_ OF \_\_\_\_\_  
 DATE \_\_\_\_\_  
 DRAWN BY \_\_\_\_\_

**Note: Any and all changes must be submitted to Lynden Door in writing. No verbal changes will be accepted. Accuracy of information is the responsibility of the customer.**

### HINGE

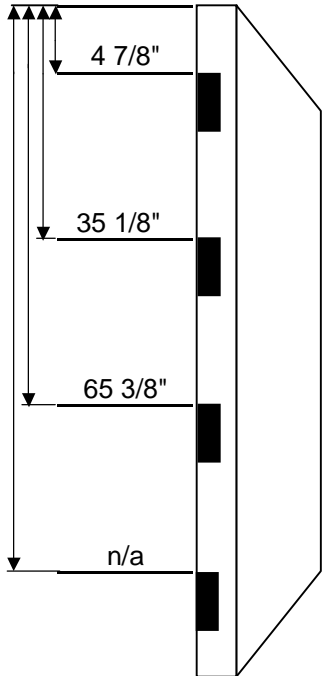

#### HINGES

SIZE 4 1/2"  
 BACKSET 1/4"  
 THICKNESS .134"  
 PIVOT \_\_\_\_\_  
 TEMPLATE NO. \_\_\_\_\_

#### HINGE CORNERS

- 1/4" Radius
- 5/8" Radius
- Square

#### 3 degree BEVELS

- Lock Edge
- Hinge Edge

**NOTE:** WHEN WIRE CHASE IS REQUIRED, DESIGNATE HINGE TO RECEIVE WIRE WITH AN "X"

### ACTIVE

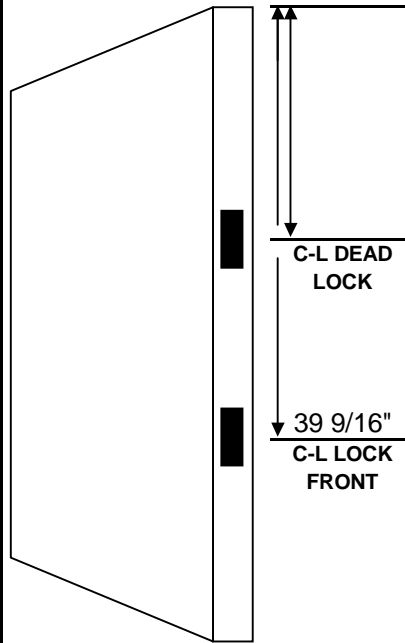

#### LOCKS / EXIT DEVICES

	BORED LOCK	DEAD LOCK
FACE BORE	_____	_____
BOLT BORE	_____	_____
BACKSET	_____	_____
F-P THICKNESS	_____	_____
F-PLATE WIDTH	_____	_____
F-P HEIGHT	_____	_____

#### CORNERS

- 1/4" Radius
- 5/8" Radius
- Square

MORTISE LOCK \_\_\_\_\_  
 CARD LOCK \_\_\_\_\_  
 EXIT DEVICE \_\_\_\_\_

MANUFACTURER \_\_\_\_\_  
 TEMPLATE NO. \_\_\_\_\_  
 FUNCTION NO. \_\_\_\_\_

**NOTE:** \* EXIT DEVICE BACK-SET SHALL BE GIVEN AS THE DISTANCE FROM C-L OF DEVICE TO C-L OF DOOR THICKNESS AT LOCK STILE UNLESS OTHERWISE NOTED.

### INACTIVE

#### STRIKES

- 1-1/4 X 4-7/8" ASA
- 1-1/8 X 2-3/4" LIP
- 1-1/8 X 2-3/4" D-BOLT

DUSTBOX

OTHER \_\_\_\_\_  
 MFG. \_\_\_\_\_  
 TEMP. \_\_\_\_\_

#### FLUSH BOLTS

MFG. \_\_\_\_\_  
 TEMP. NO. \_\_\_\_\_  
 CORNER PRE \_\_\_\_\_

#### 3 degree BEVELS

- Lock Edge
- Hinge Edge

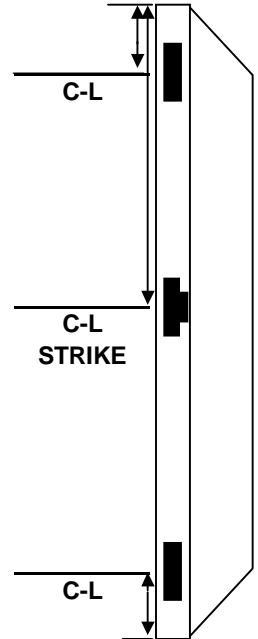

LIABILITY FOR MACHINING ACCURACY WILL BE ASSUMED ONLY UPON RECEIPT OF TEMPLATE, COMPLETED LYNDEN DOOR DETAIL SHEETS AND PHYSICAL SAMPLES AS REQUIRED.

SPEC. NO.

SPEC. NO.

## Republic 6'8" Locations

Revised 07-23-19

2077 MAIN STREET P.O. BOX 528 LYNDEN, WA 98264  
 PH (360)354.5676 FAX (360)318-8687

 CUSTOMER \_\_\_\_\_  
 P. O. NUMBER \_\_\_\_\_

 DATE \_\_\_\_\_  
 DRAWN BY \_\_\_\_\_

**Note: Any and all changes must be submitted to Lynden Door in writing. No verbal changes will be accepted. Accuracy of information is the responsibility of the customer.**

### HINGE

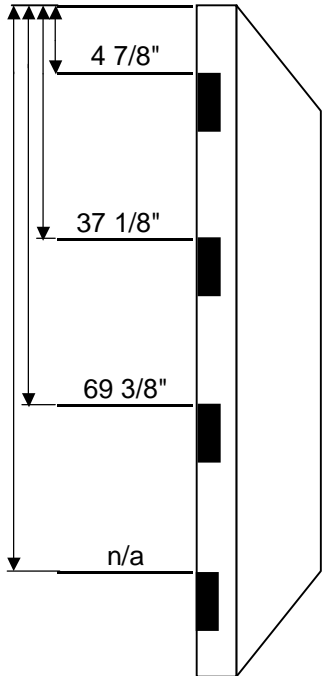

#### HINGES

 SIZE 4 1/2"  
 BACKSET 1/4"  
 THICKNESS .134"  
 PIVOT \_\_\_\_\_  
 TEMPLATE NO. \_\_\_\_\_

#### HINGE CORNERS

- 1/4" Radius  
 5/8" Radius  
 Square

#### 3 degree BEVELS

- Lock Edge  
 Hinge Edge

**NOTE:** WHEN WIRE CHASE IS REQUIRED, DESIGNATE HINGE TO RECEIVE WIRE WITH AN "X"

### ACTIVE

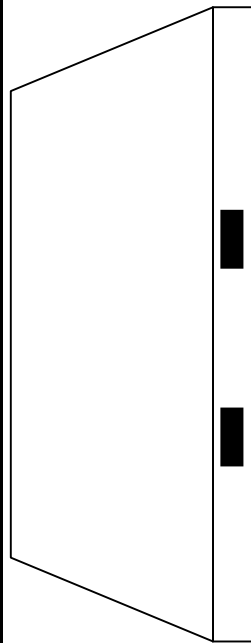

#### LOCKS / EXIT DEVICES

	BORED LOCK	DEAD LOCK
FACE BORE	_____	_____
BOLT BORE	_____	_____
BACKSET	_____	_____
F-P THICKNESS	_____	_____
F-PLATE WIDTH	_____	_____
F-P HEIGHT	_____	_____

#### CORNERS

- 1/4" Radius   
 5/8" Radius   
 Square

MORTISE LOCK \_\_\_\_\_  
 CARD LOCK \_\_\_\_\_  
 EXIT DEVICE \_\_\_\_\_

MANUFACTURER \_\_\_\_\_  
 TEMPLATE NO. \_\_\_\_\_  
 FUNCTION NO. \_\_\_\_\_

**NOTE:** \* EXIT DEVICE BACK-SET SHALL BE GIVEN AS THE DISTANCE FROM C-L OF DEVICE TO C-L OF DOOR THICKNESS AT LOCK STILE UNLESS OTHERWISE NOTED.

### INACTIVE

#### STRIKES

- 1-1/4 X 4-7/8" ASA  
 1-1/8 X 2-3/4" LIP  
 1-1/8 X 2-3/4" D-BOLT

DUSTBOX

OTHER \_\_\_\_\_  
 MFG. \_\_\_\_\_  
 TEMP. \_\_\_\_\_

#### FLUSH BOLTS

MFG. \_\_\_\_\_  
 TEMP. NO. \_\_\_\_\_  
 CORNER PRE \_\_\_\_\_

#### 3 degree BEVELS

- Lock Edge  
 Hinge Edge

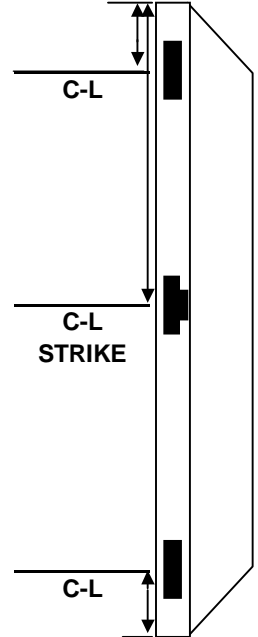

LIABILITY FOR MACHINING ACCURACY WILL BE ASSUMED ONLY UPON RECEIPT OF TEMPLATE, COMPLETED LYNDEN DOOR DETAIL SHEETS AND PHYSICAL SAMPLES AS REQUIRED.

SPEC. NO.

SPEC. NO.

## Republic 7'0" Locations

Revised 07/23/19

2077 MAIN STREET P.O. BOX 528 LYNDEN, WA 98264  
 PH (360)354.5676 FAX (360)318-8687

CUSTOMER \_\_\_\_\_  
 P. O. NUMBER \_\_\_\_\_

PAGE \_\_\_\_\_ OF \_\_\_\_\_  
 DATE \_\_\_\_\_  
 DRAWN BY \_\_\_\_\_

**Note: Any and all changes must be submitted to Lynden Door in writing. No verbal changes will be accepted. Accuracy of information is the responsibility of the customer.**

### HINGE

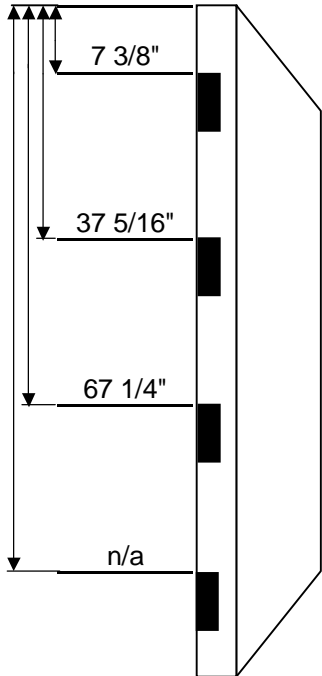

#### HINGES

SIZE 4 1/2"  
 BACKSET 1/4"  
 THICKNESS .134"  
 PIVOT \_\_\_\_\_  
 TEMPLATE NO. \_\_\_\_\_

#### HINGE CORNERS

- 1/4" Radius
- 5/8" Radius
- Square

#### 3 degree BEVELS

- Lock Edge
- Hinge Edge

**NOTE:** WHEN WIRE CHASE IS REQUIRED, DESIGNATE HINGE TO RECEIVE WIRE WITH AN "X"

### ACTIVE

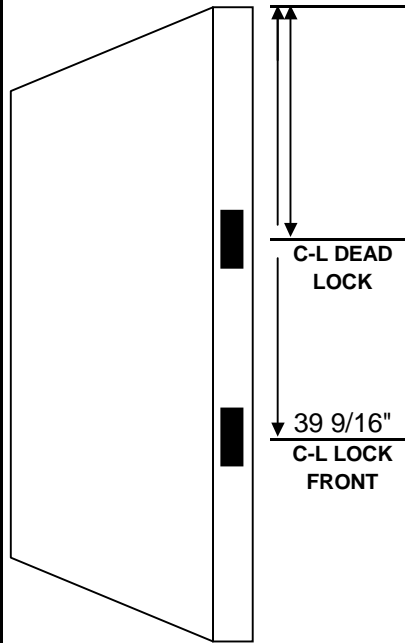

#### LOCKS / EXIT DEVICES

	BORED LOCK	DEAD LOCK
FACE BORE	_____	_____
BOLT BORE	_____	_____
BACKSET	_____	_____
F-P THICKNESS	_____	_____
F-PLATE WIDTH	_____	_____
F-P HEIGHT	_____	_____

#### CORNERS

- 1/4" Radius
- 5/8" Radius
- Square

MORTISE LOCK \_\_\_\_\_  
 CARD LOCK \_\_\_\_\_  
 EXIT DEVICE \_\_\_\_\_

MANUFACTURER \_\_\_\_\_  
 TEMPLATE NO. \_\_\_\_\_  
 FUNCTION NO. \_\_\_\_\_

**NOTE:** \* EXIT DEVICE BACK-SET SHALL BE GIVEN AS THE DISTANCE FROM C-L OF DEVICE TO C-L OF DOOR THICKNESS AT LOCK STILE UNLESS OTHERWISE NOTED.

### INACTIVE

#### STRIKES

- 1-1/4 X 4-7/8" ASA
- 1-1/8 X 2-3/4" LIP
- 1-1/8 X 2-3/4" D-BOLT

DUSTBOX

OTHER \_\_\_\_\_  
 MFG. \_\_\_\_\_  
 TEMP. \_\_\_\_\_

#### FLUSH BOLTS

MFG. \_\_\_\_\_  
 TEMP. NO. \_\_\_\_\_  
 CORNER PRE \_\_\_\_\_

#### 3 degree BEVELS

- Lock Edge
- Hinge Edge

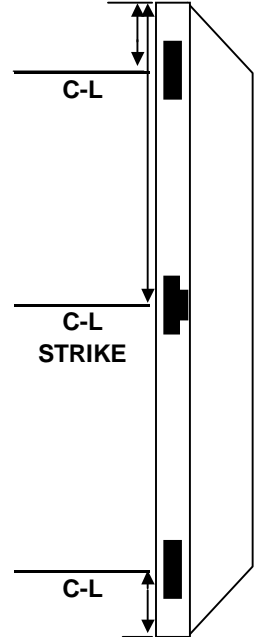

LIABILITY FOR MACHINING ACCURACY WILL BE ASSUMED ONLY UPON RECEIPT OF TEMPLATE, COMPLETED LYNDEN DOOR DETAIL SHEETS AND PHYSICAL SAMPLES AS REQUIRED.

SPEC. NO.

## Steelcraft 6'8" Locations

SPEC. NO.

2077 MAIN STREET P.O. BOX 528 LYNDEN, WA 98264  
 PH (360)354.5676 FAX (360)318-8687

 CUSTOMER \_\_\_\_\_  
 P. O. NUMBER \_\_\_\_\_

 DATE \_\_\_\_\_  
 DRAWN BY \_\_\_\_\_

**Note: Any and all changes must be submitted to Lynden Door in writing. No verbal changes will be accepted. Accuracy of information is the responsibility of the customer.**

### HINGE

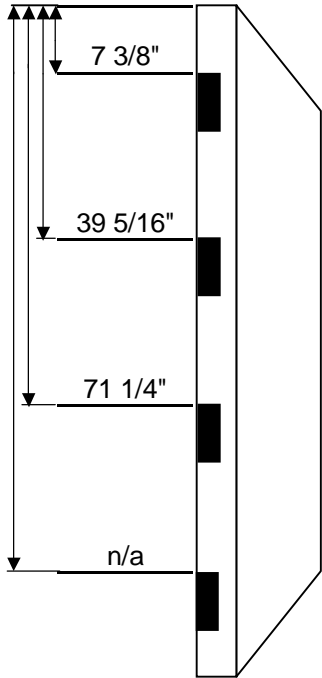

#### HINGES

 SIZE 4 1/2"  
 BACKSET 1/4"  
 THICKNESS .134"  
 PIVOT \_\_\_\_\_  
 TEMPLATE NO. \_\_\_\_\_

#### HINGE CORNERS

- 1/4" Radius  
 5/8" Radius  
 Square

#### 3 degree BEVELS

- Lock Edge  
 Hinge Edge

**NOTE:** WHEN WIRE CHASE IS REQUIRED, DESIGNATE HINGE TO RECEIVE WIRE WITH AN "X"

### ACTIVE

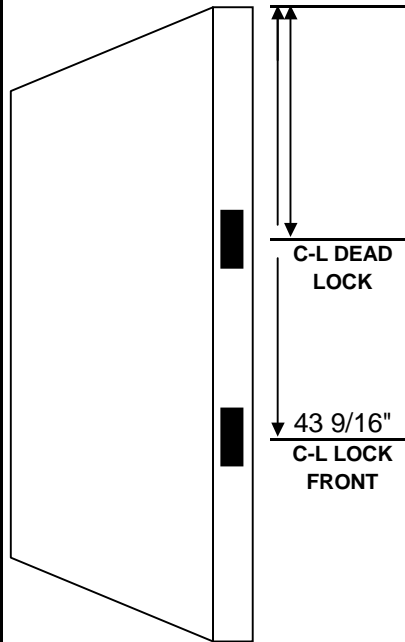

#### LOCKS / EXIT DEVICES

	BORED LOCK	DEAD LOCK
FACE BORE	_____	_____
BOLT BORE	_____	_____
BACKSET	_____	_____
F-P THICKNESS	_____	_____
F-PLATE WIDTH	_____	_____
F-P HEIGHT	_____	_____

#### CORNERS

- 1/4" Radius   
 5/8" Radius   
 Square

MORTISE LOCK \_\_\_\_\_  
 CARD LOCK \_\_\_\_\_  
 EXIT DEVICE \_\_\_\_\_

MANUFACTURER \_\_\_\_\_  
 TEMPLATE NO. \_\_\_\_\_  
 FUNCTION NO. \_\_\_\_\_

**NOTE:** \* EXIT DEVICE BACK-SET SHALL BE GIVEN AS THE DISTANCE FROM C-L OF DEVICE TO C-L OF DOOR THICKNESS AT LOCK STILE UNLESS OTHERWISE NOTED.

### INACTIVE

#### STRIKES

- 1-1/4 X 4-7/8" ASA  
 1-1/8 X 2-3/4" LIP  
 1-1/8 X 2-3/4" D-BOLT

DUSTBOX

OTHER \_\_\_\_\_  
 MFG. \_\_\_\_\_  
 TEMP. \_\_\_\_\_

#### FLUSH BOLTS

MFG. \_\_\_\_\_  
 TEMP. NO. \_\_\_\_\_  
 CORNER PRE \_\_\_\_\_

#### 3 degree BEVELS

- Lock Edge  
 Hinge Edge

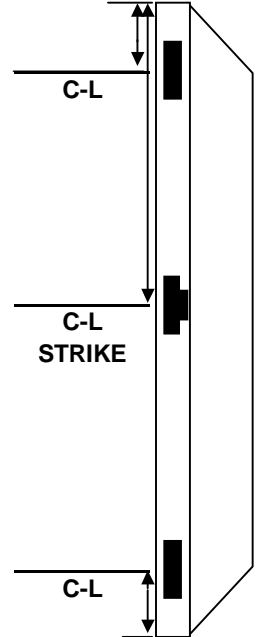

LIABILITY FOR MACHINING ACCURACY WILL BE ASSUMED ONLY UPON RECEIPT OF TEMPLATE, COMPLETED LYNDEN DOOR DETAIL SHEETS AND PHYSICAL SAMPLES AS REQUIRED.

SPEC. NO.

## Steelcraft 7'0" Locations

SPEC. NO.

**Note: Any and all changes must be submitted to Lynden Door in writing. No verbal changes will be accepted. Accuracy of information is the responsibility of the customer.**

HINGE	LOCK	SHELF DETAIL																						
<div style="text-align: center;"><b>HINGES</b></div> <p>SIZE <u>4 1/2"</u>              BACKSET <u>1/4"</u>              THICKNESS <u>.134"</u></p> <p><input type="checkbox"/> 1/4" Radius  <input type="checkbox"/> 5/8" Radius  <input checked="" type="checkbox"/> Square</p> <p>GAP <u>3/16"</u>              SHELF THICKNESS _____</p> <p><b>BEVEL EDGES</b></p> <p><input type="checkbox"/> Lock Edge  <input type="checkbox"/> Hinge Edge</p> <p><input type="checkbox"/> Straight Cut  <input type="checkbox"/> Rabbet Cut</p> <p><b>NET HEIGHT</b></p> <p>TOP LEAF: <u>39 13/16"</u>              BOTTOM LEAF: <u>43 1/8"</u>              RABBET HEIGHT: _____ H (SEE DIAGRAM--&gt;)</p> <p><small><b>NOTE:</b> NET HEIGHT MUST BE MEASURED FROM THE LONGEST POINT OF EACH LEAF IF RABBET IS USED.</small></p>	<div style="text-align: center;"><b>LOCKS / EXIT DEVICES</b></div> <table border="0" style="width:100%;"> <tr> <td style="width:50%; text-align: center;"><b>BORED LOCK</b></td> <td style="width:50%; text-align: center;"><b>DEAD LOCK</b></td> </tr> <tr> <td>FACE BORE _____</td> <td>_____</td> </tr> <tr> <td>BOLT BORE _____</td> <td>_____</td> </tr> <tr> <td>BACKSET _____</td> <td>_____</td> </tr> <tr> <td>F-P THICKNESS _____</td> <td>_____</td> </tr> <tr> <td>F-PLATE WIDTH _____</td> <td>_____</td> </tr> <tr> <td>F-P HEIGHT _____</td> <td>_____</td> </tr> </table> <p>CORNERS <input type="checkbox"/> 1/4" Radius <input type="checkbox"/>  <input type="checkbox"/> Square <input type="checkbox"/></p> <p><b>C-L DEAD LOCK</b></p> <p><b>C-L LOCK FRONT</b></p> <p>MORTISE LOCK _____              UNIT LOCK _____              EXIT DEVICE _____</p> <p>MANUFACTURER _____              TEMPLATE NO. _____              FUNCTION NO. _____</p>	<b>BORED LOCK</b>	<b>DEAD LOCK</b>	FACE BORE _____	_____	BOLT BORE _____	_____	BACKSET _____	_____	F-P THICKNESS _____	_____	F-PLATE WIDTH _____	_____	F-P HEIGHT _____	_____	<div style="text-align: center;"><b>STANDARD SHELF THICKNESS IS 3/4"</b></div> <p>OUTSIDE SHELF - OUTSWING DOOR - FLUSH OR OVERLAPPING <input type="checkbox"/></p> <p>OUTSIDE SHELF - INSWING DOOR - OVERLAPPING <input type="checkbox"/></p> <p>OUTSIDE SHELF - INSWING DOOR - FLUSH MOUNT 1-1/2" NARROWER THAN DOOR <input checked="" type="checkbox"/></p> <p>DOUBLE SHELF <input type="checkbox"/></p> <div style="text-align: center;"><b>SHELF SIZE</b></div> <table border="0" style="width:100%;"> <tr> <td style="width:50%; text-align: center;"><b>SINGLE SHELF</b></td> <td style="width:50%; text-align: center;"><b>DOUBLE SHELF</b></td> </tr> <tr> <td><input type="checkbox"/> 5"</td> <td><input type="checkbox"/> 10"</td> </tr> <tr> <td><input type="checkbox"/> 6"</td> <td><input type="checkbox"/> 12"</td> </tr> <tr> <td><input type="checkbox"/> 8"</td> <td><input type="checkbox"/> 14"</td> </tr> </table>	<b>SINGLE SHELF</b>	<b>DOUBLE SHELF</b>	<input type="checkbox"/> 5"	<input type="checkbox"/> 10"	<input type="checkbox"/> 6"	<input type="checkbox"/> 12"	<input type="checkbox"/> 8"	<input type="checkbox"/> 14"
<b>BORED LOCK</b>	<b>DEAD LOCK</b>																							
FACE BORE _____	_____																							
BOLT BORE _____	_____																							
BACKSET _____	_____																							
F-P THICKNESS _____	_____																							
F-PLATE WIDTH _____	_____																							
F-P HEIGHT _____	_____																							
<b>SINGLE SHELF</b>	<b>DOUBLE SHELF</b>																							
<input type="checkbox"/> 5"	<input type="checkbox"/> 10"																							
<input type="checkbox"/> 6"	<input type="checkbox"/> 12"																							
<input type="checkbox"/> 8"	<input type="checkbox"/> 14"																							

SPECIAL INSTRUCTIONS

SPEC NO.	<h1>7'0 Steelcraft Dutch Door - Non Rated                  3/16" Clearance Between Leaves</h1>	(with	SHELF DETAIL LETTER
----------	--	-------	---------------------



2077 MAIN STREET P.O. BOX 528 LYNDEN, WA 98264  
 PH (360)354.5676 FAX (360)318-8687

 CUSTOMER \_\_\_\_\_  
 P. O. NUMBER \_\_\_\_\_

 DATE \_\_\_\_\_  
 DRAWN BY \_\_\_\_\_

Note: Any and all changes must be submitted to Lynden Door in writing. No verbal changes will be accepted. Accuracy of information is the responsibility of the customer.

### HINGE

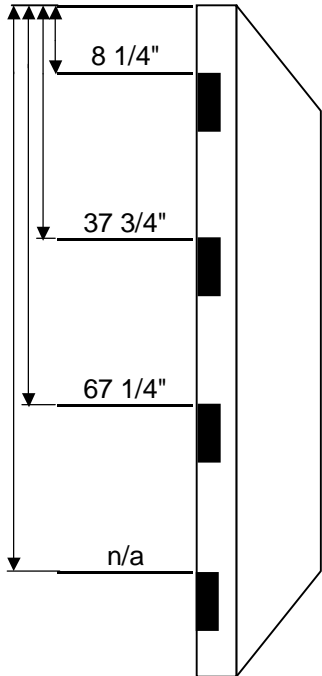

#### HINGES

 SIZE 4 1/2"  
 BACKSET 1/4"  
 THICKNESS .134"  
 PIVOT \_\_\_\_\_  
 TEMPLATE NO. \_\_\_\_\_

#### HINGE CORNERS

- 1/4" Radius  
 5/8" Radius  
 Square

#### 3 degree BEVELS

- Lock Edge  
 Hinge Edge

NOTE: WHEN WIRE CHASE IS REQUIRED, DESIGNATE HINGE TO RECEIVE WIRE WITH AN "X"

### ACTIVE

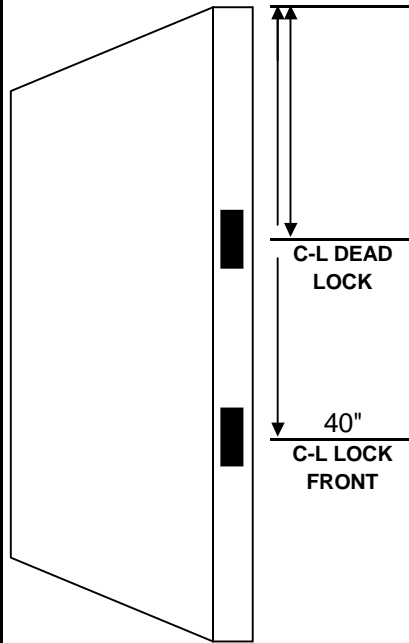

#### LOCKS / EXIT DEVICES

	BORED LOCK	DEAD LOCK
FACE BORE	_____	_____
BOLT BORE	_____	_____
BACKSET	_____	_____
F-P THICKNESS	_____	_____
F-PLATE WIDTH	_____	_____
F-P HEIGHT	_____	_____

#### CORNERS

- 1/4" Radius   
 5/8" Radius   
 Square

MORTISE LOCK \_\_\_\_\_  
 CARD LOCK \_\_\_\_\_  
 EXIT DEVICE \_\_\_\_\_

MANUFACTURER \_\_\_\_\_  
 TEMPLATE NO. \_\_\_\_\_  
 FUNCTION NO. \_\_\_\_\_

NOTE: \* EXIT DEVICE BACK-SET SHALL BE GIVEN AS THE DISTANCE FROM C-L OF DEVICE TO C-L OF DOOR THICKNESS AT LOCK STILE UNLESS OTHERWISE NOTED.

### INACTIVE

#### STRIKES

- 1-1/4 X 4-7/8" ASA  
 1-1/8 X 2-3/4" LIP  
 1-1/8 X 2-3/4" D-BOLT

DUSTBOX

OTHER \_\_\_\_\_  
 MFG. \_\_\_\_\_  
 TEMP. \_\_\_\_\_

#### FLUSH BOLTS

MFG. \_\_\_\_\_  
 TEMP. NO. \_\_\_\_\_  
 CORNER PRE \_\_\_\_\_

#### 3 degree BEVELS

- Lock Edge  
 Hinge Edge

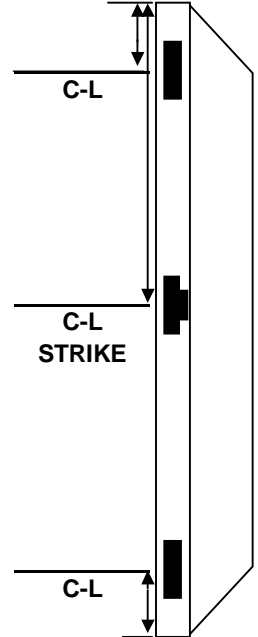

LIABILITY FOR MACHINING ACCURACY WILL BE ASSUMED ONLY UPON RECEIPT OF TEMPLATE, COMPLETED LYNDEN DOOR DETAIL SHEETS AND PHYSICAL SAMPLES AS REQUIRED.

SPEC. NO.

## Timely 6'8" Locations

SPEC. NO.

2077 MAIN STREET P.O. BOX 528 LYNDEN, WA 98264  
 PH (360)354.5676 FAX (360)318-8687

 CUSTOMER \_\_\_\_\_  
 P. O. NUMBER \_\_\_\_\_

 DATE \_\_\_\_\_  
 DRAWN BY \_\_\_\_\_

**Note: Any and all changes must be submitted to Lynden Door in writing. No verbal changes will be accepted. Accuracy of information is the responsibility of the customer.**

### HINGE

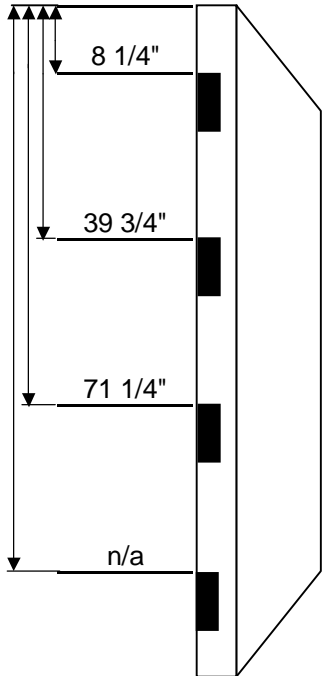

#### HINGES

 SIZE 4 1/2"  
 BACKSET 1/4"  
 THICKNESS .134"  
 PIVOT \_\_\_\_\_  
 TEMPLATE NO. \_\_\_\_\_

#### HINGE CORNERS

- 1/4" Radius  
 5/8" Radius  
 Square

#### 3 degree BEVELS

- Lock Edge  
 Hinge Edge

**NOTE:** WHEN WIRE CHASE IS REQUIRED, DESIGNATE HINGE TO RECEIVE WIRE WITH AN "X"

### ACTIVE

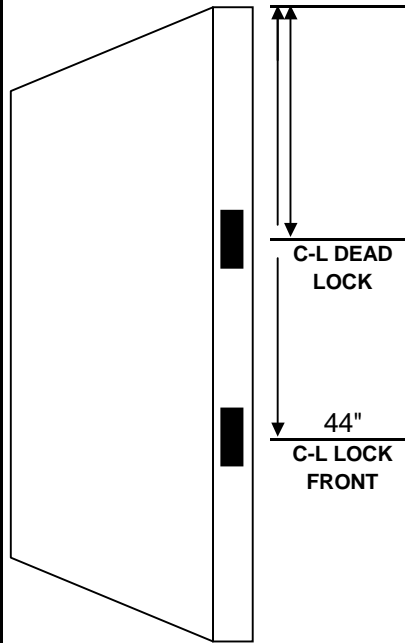

#### LOCKS / EXIT DEVICES

	BORED LOCK	DEAD LOCK
FACE BORE	_____	_____
BOLT BORE	_____	_____
BACKSET	_____	_____
F-P THICKNESS	_____	_____
F-PLATE WIDTH	_____	_____
F-P HEIGHT	_____	_____

#### CORNERS

- 1/4" Radius   
 5/8" Radius   
 Square

MORTISE LOCK \_\_\_\_\_  
 CARD LOCK \_\_\_\_\_  
 EXIT DEVICE \_\_\_\_\_

MANUFACTURER \_\_\_\_\_  
 TEMPLATE NO. \_\_\_\_\_  
 FUNCTION NO. \_\_\_\_\_

**NOTE:** \* EXIT DEVICE BACK-SET SHALL BE GIVEN AS THE DISTANCE FROM C-L OF DEVICE TO C-L OF DOOR THICKNESS AT LOCK STILE UNLESS OTHERWISE NOTED.

### INACTIVE

#### STRIKES

- 1-1/4 X 4-7/8" ASA  
 1-1/8 X 2-3/4" LIP  
 1-1/8 X 2-3/4" D-BOLT

DUSTBOX

OTHER \_\_\_\_\_  
 MFG. \_\_\_\_\_  
 TEMP. \_\_\_\_\_

#### FLUSH BOLTS

MFG. \_\_\_\_\_  
 TEMP. NO. \_\_\_\_\_  
 CORNER PRE \_\_\_\_\_

#### 3 degree BEVELS

- Lock Edge  
 Hinge Edge

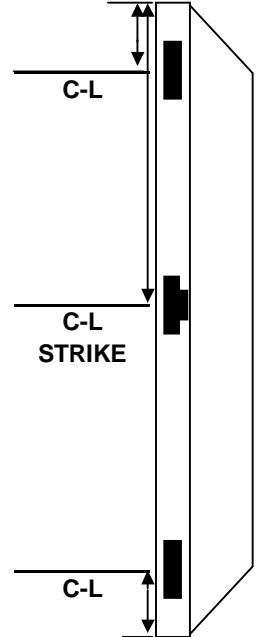

LIABILITY FOR MACHINING ACCURACY WILL BE ASSUMED ONLY UPON RECEIPT OF TEMPLATE, COMPLETED LYNDEN DOOR DETAIL SHEETS AND PHYSICAL SAMPLES AS REQUIRED.

SPEC. NO.

SPEC. NO.

## Timely 7'0" Locations

2077 MAIN STREET P.O. BOX 528 LYNDEN, WA 98264  
 PH (360)354.5676 FAX (360)318-8687

CUSTOMER \_\_\_\_\_  
 P. O. NUMBER \_\_\_\_\_

PAGE \_\_\_\_\_ OF \_\_\_\_\_  
 DATE \_\_\_\_\_  
 DRAWN BY \_\_\_\_\_

**Note: Any and all changes must be submitted to Lynden Door in writing. No verbal changes will be accepted. Accuracy of information is the responsibility of the customer.**

### HINGE

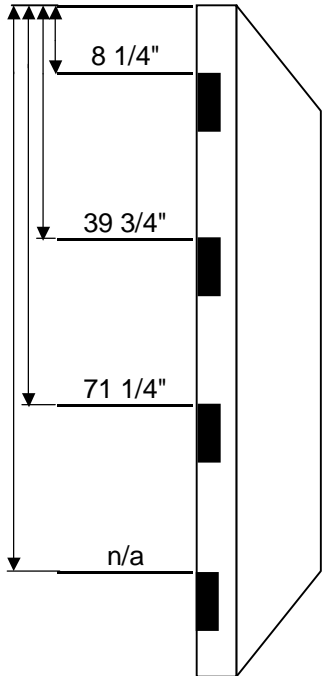

#### HINGES

SIZE 4 1/2"  
 BACKSET 1/4"  
 THICKNESS .134"  
 PIVOT \_\_\_\_\_  
 TEMPLATE NO. \_\_\_\_\_

#### HINGE CORNERS

- 1/4" Radius
- 5/8" Radius
- Square

#### 3 degree BEVELS

- Lock Edge
- Hinge Edge

**NOTE:** WHEN WIRE CHASE IS REQUIRED, DESIGNATE HINGE TO RECEIVE WIRE WITH AN "X"

### ACTIVE

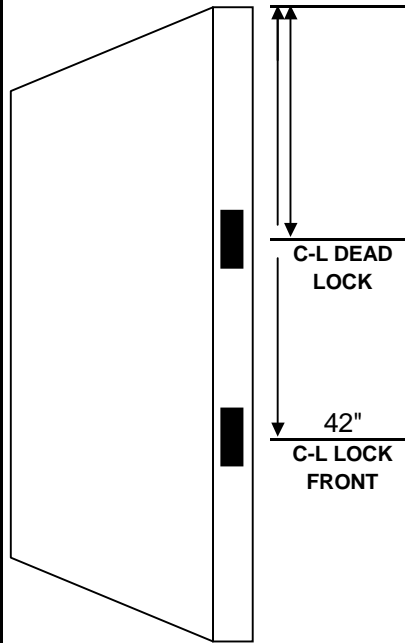

#### LOCKS / EXIT DEVICES

	BORED LOCK	DEAD LOCK
FACE BORE	_____	_____
BOLT BORE	_____	_____
BACKSET	_____	_____
F-P THICKNESS	_____	_____
F-PLATE WIDTH	_____	_____
F-P HEIGHT	_____	_____

#### CORNERS

- 1/4" Radius
- 5/8" Radius
- Square

MORTISE LOCK \_\_\_\_\_  
 CARD LOCK \_\_\_\_\_  
 EXIT DEVICE \_\_\_\_\_

MANUFACTURER \_\_\_\_\_  
 TEMPLATE NO. \_\_\_\_\_  
 FUNCTION NO. \_\_\_\_\_

**NOTE:** \* EXIT DEVICE BACK-SET SHALL BE GIVEN AS THE DISTANCE FROM C-L OF DEVICE TO C-L OF DOOR THICKNESS AT LOCK STILE UNLESS OTHERWISE NOTED.

### INACTIVE

#### STRIKES

- 1-1/4 X 4-7/8" ASA
- 1-1/8 X 2-3/4" LIP
- 1-1/8 X 2-3/4" D-BOLT

DUSTBOX

OTHER \_\_\_\_\_  
 MFG. \_\_\_\_\_  
 TEMP. \_\_\_\_\_

#### FLUSH BOLTS

MFG. \_\_\_\_\_  
 TEMP. NO. \_\_\_\_\_  
 CORNER PRE \_\_\_\_\_

#### 3 degree BEVELS

- Lock Edge
- Hinge Edge

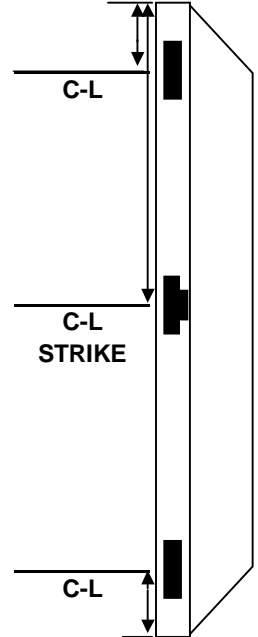

LIABILITY FOR MACHINING ACCURACY WILL BE ASSUMED ONLY UPON RECEIPT OF TEMPLATE, COMPLETED LYNDEN DOOR DETAIL SHEETS AND PHYSICAL SAMPLES AS REQUIRED.

SPEC. NO.

SPEC. NO.

## Timely 7'0" Reversible Locations

2077 MAIN STREET P.O. BOX 528 LYNDEN, WA 98264  
 PH (360)354.5676 FAX (360)318-8687

 CUSTOMER \_\_\_\_\_  
 P. O. NUMBER \_\_\_\_\_

 DATE \_\_\_\_\_  
 DRAWN BY \_\_\_\_\_

**Note: Any and all changes must be submitted to Lynden Door in writing. No verbal changes will be accepted. Accuracy of information is the responsibility of the customer.**

### HINGE

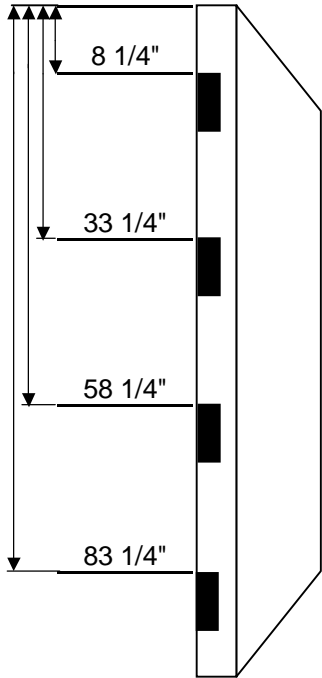

#### HINGES

 SIZE 4 1/2"  
 BACKSET 1/4"  
 THICKNESS .134"  
 PIVOT \_\_\_\_\_  
 TEMPLATE NO. \_\_\_\_\_

#### HINGE CORNERS

- 1/4" Radius  
 5/8" Radius  
 Square

#### 3 degree BEVELS

- Lock Edge  
 Hinge Edge

**NOTE:** WHEN WIRE CHASE IS REQUIRED, DESIGNATE HINGE TO RECEIVE WIRE WITH AN "X"

### ACTIVE

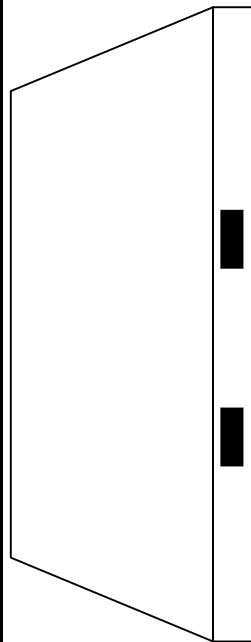

#### LOCKS / EXIT DEVICES

	BORED LOCK	DEAD LOCK
FACE BORE	_____	_____
BOLT BORE	_____	_____
BACKSET	_____	_____
F-P THICKNESS	_____	_____
F-PLATE WIDTH	_____	_____
F-P HEIGHT	_____	_____

#### CORNERS

- 1/4" Radius   
 5/8" Radius   
 Square

MORTISE LOCK \_\_\_\_\_  
 CARD LOCK \_\_\_\_\_  
 EXIT DEVICE \_\_\_\_\_

MANUFACTURER \_\_\_\_\_  
 TEMPLATE NO. \_\_\_\_\_  
 FUNCTION NO. \_\_\_\_\_

**NOTE:** \* EXIT DEVICE BACK-SET SHALL BE GIVEN AS THE DISTANCE FROM C-L OF DEVICE TO C-L OF DOOR THICKNESS AT LOCK STILE UNLESS OTHERWISE NOTED.

### INACTIVE

#### STRIKES

- 1-1/4 X 4-7/8" ASA  
 1-1/8 X 2-3/4" LIP  
 1-1/8 X 2-3/4" D-BOLT

DUSTBOX

OTHER \_\_\_\_\_  
 MFG. \_\_\_\_\_  
 TEMP. \_\_\_\_\_

#### FLUSH BOLTS

MFG. \_\_\_\_\_  
 TEMP. NO. \_\_\_\_\_  
 CORNER PRE \_\_\_\_\_

#### 3 degree BEVELS

- Lock Edge  
 Hinge Edge

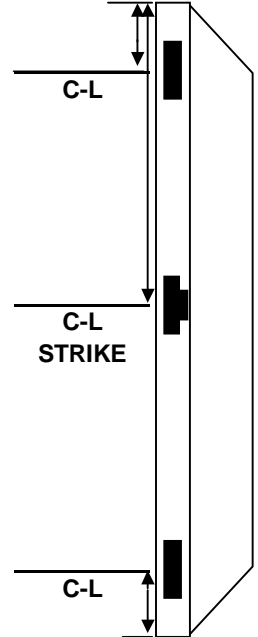

LIABILITY FOR MACHINING ACCURACY WILL BE ASSUMED ONLY UPON RECEIPT OF TEMPLATE, COMPLETED LYNDEN DOOR DETAIL SHEETS AND PHYSICAL SAMPLES AS REQUIRED.

SPEC. NO.

## Timely 8'0" Reversible Locations

SPEC. NO.